

Optimization of Distance on the Transmission of Long Haul WDM System

Mohd Hazim Mohamed Harith,
 Faculty of Electrical Engineering, Universiti Teknologi Mara (UiTM)
 40450- Shah Alam, Selangor, Malaysia
 hazimharith87@yahoo.com

Abstract—This project presents the design of Wavelength Division Multiplexing (WDM) with different channel and distances. In view of the current requirement for high bandwidth and transmission speed, optical fiber is being extensively used for data transmission. As the transmission system evolves to longer distance and higher bit/ rates, this technology become more useful and widely use. Optical fiber is use as a medium for telecommunication and networking because it is flexible and can be bundled as cables. WDM system is very suitable for long distance communication. Objective of this project is to design WDM system with multiple channels for long distance application and simulated it in OptiSystem software version 7.0. The transmitter will transmit signal with multiple wavelength (channels) and multiplexer will combine all the wavelength to travel in Single Mode Fiber (SMF) for long distance. At the receiver, the optical demultiplexer separates out the WDM signal and direct them to the individual channel receiver. The signal will be analyze base on Q- factor, min BER, noise and signal power. This data is successfully collect and present in graph with different channel varies with distances. The overall of the project conclude that the signal quality will decrease when the distance increased.

Keywords— Wavelength Division Multiplexing (WDM), Single Mode Fiber (SMF), channel, distance, Q- factor, min BER, noise, signal power.

I. INTRODUCTION

Fiber optic communication is method of transmitting information data from one place to another place by sending pulses of light through optical fiber. The light form an electromagnetic carrier wave that is modulated to carry information. First developed in the 1970s, fiber optic communication system has revolutionized the telecommunication industry and has played a major role in the advent of the information age. Because of its advantages over electrical transmission, optical fiber has largely replaced copper wire telecommunication in core networks in the developed world. The aim of optical communication is to transmit the maximum number of bits per seconds over the maximum possible distance with lowers error. There are many types of modulation schemes employed for long haul optical communication and one of the techniques is wavelength division multiplexing [1].

A WDM is basically a fiber optical transmission technique, which multiplexes many signals of different wavelength and is capable of providing data capacity in excess of hundreds of gigabit per second over thousands of kilometers in a single mode fiber. At present, most countries

have implemented Internet infrastructure by means of WDM systems to provide high bandwidth and a high-speed Internet service. A WDM system is needed to support communication system, which currently transmits more than data rate of 40 Gb/s per wavelength channel on a single mode fiber over a long distance. No other systems apart from WDM system can support these scalable high speeds and huge bandwidth over a longer distance.

The WDM system use optical fibers for data transmission, which is more secure compared with other data transmission systems, e.g., satellite, from tapping (as light does not radiate from the fiber, it is nearly impossible to tap into it secretly without detection) and is also immune to interference and crosstalk [2].

Although optical fiber has a lot of advantages it is also had the disadvantages. In fiber optic, data that send along the fiber will be corrupted along the fiber. This phenomenon happens because of the losses and dispersion that occur in fiber optic. There are several analysis and simulation had been done on WDM systems based on the system performance [1]- [4].

The objective of this project is to design and analyze the WDM technique with multiple channels (8, 16, & 32) using two different type of transmitter which are standard WDM transmitter and external modulator transmitter in a long haul optical fiber communication system over the single mode fiber (SMF) cable. This project also will focus on ideal distance that is needed to amplify the signal power by using Erbium Doped Fiber Amplifier (EDFA). All the designs are simulated using OptiSystem 7.0 software and the result of Q-factor, min BER, noise and signal power will be analyzed.

II. METHODOLOGY

The basic design of the WDM system in this project can be divided into three main parts which are transmitter, fiber cable and receiver.

The simulation of this project has been divided into two parts. The first part is the comparison between two different transmitter type which are standard WDM transmitter and external modulator transmitter. The second part of the analysis focuses on the transmitting signal with external modulator that varies with distances. All the design and simulation processes are done with OptiSystem software.

2.1 Flow Chart

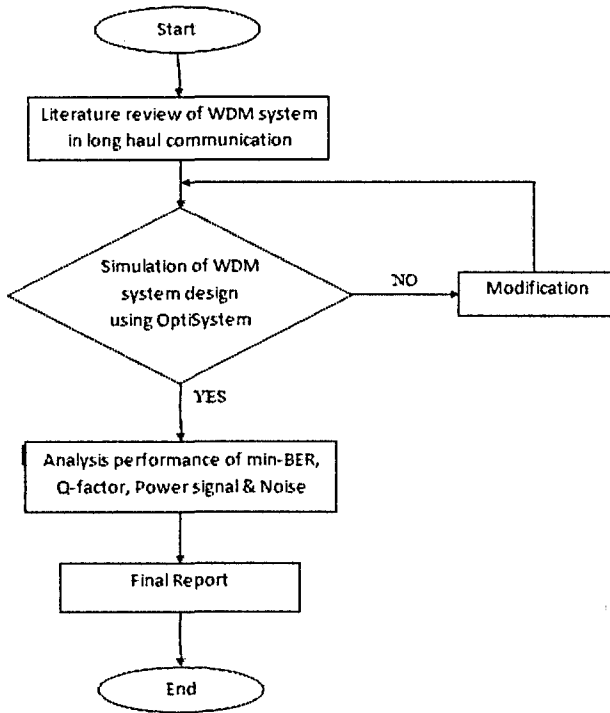

Figure 1: Flow Chart

2.2 Design the WDM system

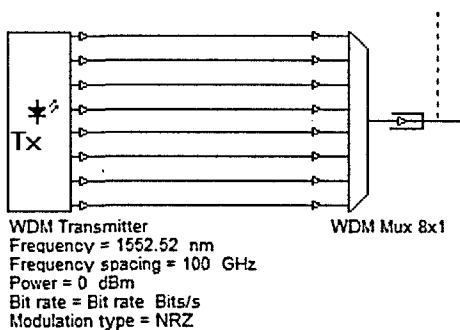

Figure 2: Standard WDM transmitter

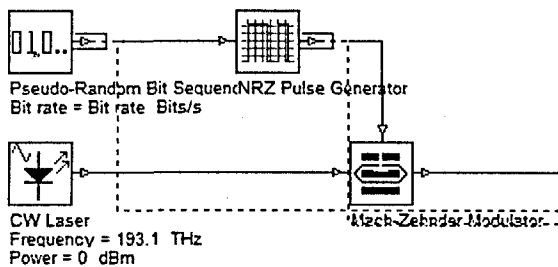

Figure 3: External modulator transmitter

Figure 2 shows Standard WDM transmitter while Figure 3 shows External modulator transmitter. Three different

channels have been analyzed consist of 8, 16 and 32 channels.

As in transmission medium, the SMF is chosen between the transmitter to receiver to carry signal for long distance communication. There are several distances has been put to analyze the performance of the system. Every channel is design to have an ideal SMF design which consist of 50 km SMF and a 20 dB gain of EDFA.

The last part is the receiver at the end node of the transmission process. At the receiver, the optical demultiplexer has been implant to the system. The optical demultiplexer separates out the WDM signal and directs them to the individual channel receiver.

The simulator that will be used in this analysis is the OptiSystem 7.0 software. The simulation process will be dividing into two parts. The first part is the comparison of the performance between two types of transmitter which are standard WDM transmitter and external modulator transmitter. The performance of the system are analyze through the Q-factor, min BER, noise and power. Figure 4 shows the WDM system.

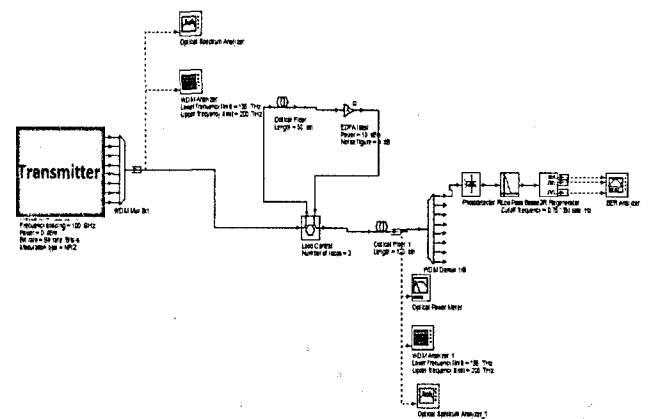

Figure 4: System design of WDM with SMF

III. RESULT & DISCUSSION

Performance analysis of the system is evaluated in terms of Q- factor, min BER, noise and power. These performance criteria are evaluated for different value of distance and channel.

2.1 Standard WDM versus External modulator

Table I: Standard WDM vs External modulator

	Distance (KM)	50
external modulator	Q Factor	21.61852
	Min. BER	0.000E+00
	SNR (dB)	38.3211
	Signal Power (dBm)	-0.065
	Noise Power (dBm)	-17.254
	Total Power (dBm)	0.017
standard wdm	Q Factor	21.04187
	Min. BER	0.00E+00
	SNR (dB)	38.274
	Signal Power (dBm)	-0.063
	Noise Power (dBm)	-17.346
	Total Power (dBm)	0.017

Table 1 shows result between standard WDM transmitter and external modulator transmitter with the minimum of channels. The fiber length is fixed to 50 Km. The value of Q-factor and SNR for external modulator is better than standard WDM which are 21.61852 and 38.3211dB respectively. These results proved that the external modulator much better than standard WDM transmitting method.

External modulator is better than standard WDM because of the external modulated laser used is more stable. It has external modulation which can avoid non-linearity excessive chirp which can occupies less bandwidth in the system. Typically Mach Zender Modulator is used in the design in order to increase the bandwidth. This also means that the spacing between adjacent channels in WDM can be greatly reduced.

2.2 Performance of transmission using external modulator with different channel that varies by distance.

For the whole WDM system, the analysis has been focusing more on external modulator transmitter to study the performance of WDM. This analysis has been done by comparing the multiple channels varies by distances to study the performance for each channel.

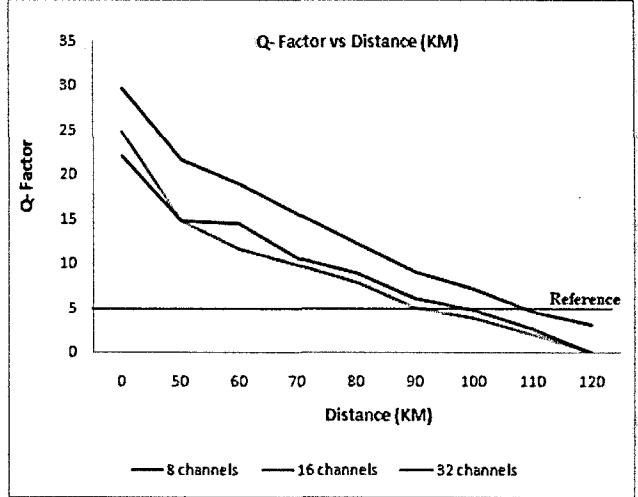

Figure 5: Graph of Q-factor vs Distance (KM)

Figure 5 show the performance analysis for each 8, 16 and 32 channels in term of Q- factor value. The value of Q- factor drop when the distance increases up to 120KM. The value of Q- factor obtained below than 5 is categorized as worst and this is the point where the amplifier is needed. The 8 channel have much better value of Q- factor than 16 and 32 channels. The maximum and minimum values of Q- factor for 8 channels are 29.6 and 3.1 respectively. Figure 5 also shows that the Q-factor is inversely proportional with the distance where the value of the Q-factor will decreased when the distance increased. This happen because of attenuation occurred in longer distance.

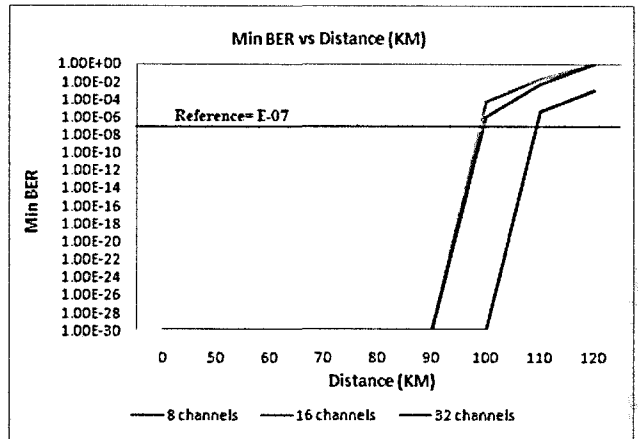

Figure 6: Graph of Min BER vs Distance (KM)

Figure 6 shows the performance analysis for each channel in term of min BER. The value of min BER will increased when the distance increases up to 120KM. The value of min BER that bigger than 10^{-7} is categorized as bad value and this is the point where the amplifier is needed. The 8 channel have much better value of min BER than 16 and 32 channels. The value of min BER at 110KM for 8 channels is 10^{-6} while for 16 and 32 channels are 10^{-2} and 10^{-3} respectively. Figure 6 also shows that the min BER is proportional with the distance

where the value of min BER will increased when the distance are increased. This happens because of chromatic dispersion.

IV. CONCLUSION

This project verified that the external modulator transmitter has more advantage compare to standard WDM transmitter due to the better performance of the Q-factor, min BER, noise and power. For the whole system, the results obtained in the term of Q- factor, min BER, noise and power. When the distance and channels increased, the Q- factor will decreased but the min BER will increased. The SNR will decreased when the channel increased while the power signal will decreased when the distance increased. This project has also identify, when the distance reach at 110KM for 8 channel and 100KM for 16 and 32 channel the amplifier should be implement to power up the Q-factor. As recommendation for further research, by implement Dispersion Compensation Fiber (DCF) in the WDM system can increase higher performance for WDM system with multiple channels for long propagation because of it has negative chromatic dispersion.

V. REFERENCES

- [1] Ratesh kumar, V P Mahadevan Pillai, K G Gopchandran, "Design and Simulation of a Optical communication system with dispersion managed RZ pulse", Department of Optoelectronics University of Kerala India.
- [2] Shaban Pazi, Chris Chatwin, Rupert Young, Philip Birch, "Analysis of a WDM system for Tanzania", Department of Engineering and Design University of Sussex, 2008.
- [3] Md Azwan Shah, "Analysis of WDM system on Optical Fiber", Section of Communication Technology Universiti Kuala Lumpur British Malaysian Institute, May 2011.
- [4] Mir Muhammad Lodro, Muhammad Ali Joyo, "32- Channel DWDM System Design and Simulation by Using EDFA with DCF and Raman Amplifiers", Department of Electrical Engineering Sukkur Institute of Business Administration Karachi Pakistan, 2012.
- [5] Fariborz Mousavi Madani, Kazuko Kikuchi, "Performace Limit of Long- Distance WDM Dispersion- Managed Transmission System Using Higher Order Dispersion Compensation Fibers", Research Center for Advance Science and Technology University of Tokyo Japan, May 1999.
- [6] Robert Pous Grebol, "Analysis of the spectrum in the communication by means of optical fibre", Promax Electronica S.A. Telecom Lab.

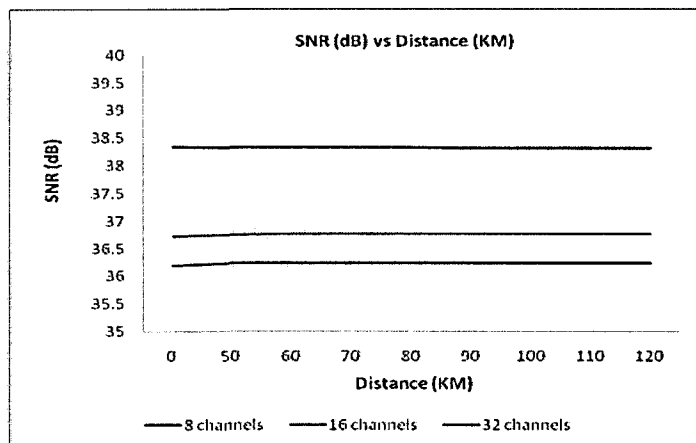

Figure 7: Graph of SNR (dB) vs Distance (KM)

The result of SNR for each channels are shown in Figure 7. The 8 channels have higher value of SNR compared with SNR of 16 and 32 channels. The average value of SNR for 8 channels is 38 dB while the average value of SNR for 16 and 32 channels are 36.7 dB and 36.2 dB respectively. This is show that the SNR is decreased when the numbers of channel increased due to dispersion that occurs during transmission. The values of SNR represent the quality of signal over the noise.

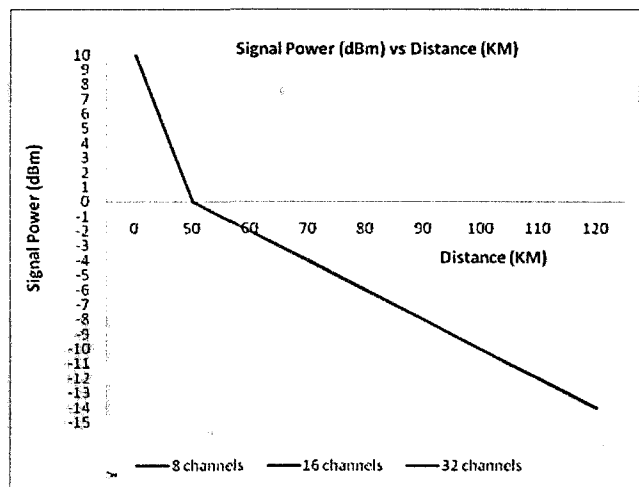

Figure 8: Graph of Signal Power (dBm) vs Distance (KM)

Figure 8 shows the increments of channels are not affect the value of signal power. However, the increasing in distance give an effect of the power signal where it shows that the power decrease when the distance increase. The values of power signal for these three channels are very close to each others.

- [7] Er. Kawal Preet Singh, Er. Navpreet Singh, Er. Gurinder Singh Dhawali, "Performance Analysis of different WDM systems", Bharat Group of Institution Sardulgarh, March 2012.
- [8] Shawn M. Esser, "WDM/ CWDM/ DWDM: Segmentation Primer- Maximizing Capacity for Revenue", Senior Product Manager Access Network Motorola Home and Product Mobility, 2008.
- [9] Dominik Bischoff, "Wavelength multiplexing: WDM and DWDM systems", February 4, 2009.
- [10] Gao Yan, Zhang Ruixian, Du Weifeng, Cui Xiaorong, "Point- to- Point DWDM System Design and Simulation", College of computer Science and Technology, Polytechnique University Henan China, August 2009.
- [11] S.B. Jun, K. J. Park, Y. C. Chung, "Transmission of 2.5-Gb/s WDM Channels Spaced at 5 GHz Over 480KM of Single-Mode Fiber", Department of Electrical Engineering Korea Advanced Institute of Science and Technology Daejon Korea, September 2003.