

# An Investigation into the Impact of Flexural Elastic Modulus on the Dimensional Instability in CNC Turning of Titanium Alloy Grade 5 - Ti6Al4V

Sangeeth Suresh

Darulihsan Abdul Hamid

MZA Yazid

Nur Rusydina Che Daud

Nik Nur Liyana Mohd Din

Universiti Kuala Lumpur – Institute of Product Design and Manufacturing,  
56100 Kuala Lumpur, Malaysia

## ABSTRACT

*Titanium Alloy Grade 5 (Ti6Al4V) has proven to be the most commonly used grade of titanium due to its excellent combination of physical and mechanical properties. However, Ti6Al4V has a relatively low modulus of elasticity (110 GPa) which in turn causes the material to be springy in nature. This springy nature of the material is a hindrance during the machining of Ti6Al4V as it may tend to push the workpiece away from the tool when the cutting force is applied. Actual dimensions are expected to change considerably from the intended dimensions due to this effect. This study attempts to investigate the magnitude of irregularity in the dimension during the CNC turning of Ti6Al4V (diameter 50mm) and the factors that significantly contribute towards the dimensional instability. The determinants of surface roughness and also the relationship between the dimensional instability and surface roughness are evaluated. Common machining parameters have been assigned as controlled and manipulated variables and an experimental design is formulated in order to record the responses through an actual standard experimental setup. It has been observed that the influence of its low elastic modulus, which is further aggravated by the depth of cut, and the generated cutting force contributes to between 25 - 40 % of residual stock on the diameter of a cylinder. The cutting force in turn significantly depends on the feed rate and the depth of cut. The higher the cutting force, the greater the deflection of the workpiece away from the cutting tool due to its flexural*

*elastic modulus, thus causing the dimensional instability in the turning process. Regardless of the depth of cut and the cutting speed, a slower feed has proven to produce a finer surface finish on the workpiece. The surface finish is positively correlated to the cutting force. However, no specific relationship is observed between the surface finish and the tool wear. Also the surface finish and the dimensional instability show no mutual dependence.*

**Keywords:** *Ti6Al4V, CNC Turning, Flexural Elastic Modulus, DOE, Correlation*

## Introduction

The sublime mechanical properties namely, specific strength, low density, fracture resistance, lightweight, corrosion resistance etc. of Ti6Al4V makes it a superior choice in engineering applications [1]. Its non-toxic and biocompatible nature along with its low elastic modulus and wear resistance makes it also an equally premium material in the medical industry, used as bone transplants, the reason being the flexibility of the alloy, which is better than the human bone [2]. The low Modulus of Elasticity in Ti6Al4V is a cause of concern during machining as it leads to a deflection and spring back of the workpiece when the cutting loads are applied and relieved respectively. This deflection subsequently causes tool vibration, chatter marks, undesired surface roughness and *dimensional instability* [3]. The forces generated while machining Ti6Al4V are relatively less than while machining materials with a high modulus of elasticity due to the shock absorbing effect caused at the tool-surface contact area [4, 5]. Titanium Alloys are considered as difficult to machine materials due to its low thermal conductivity (6.7 W/m-K), which leads to high hardness at elevated temperatures. The heat generated at the contact point between the tool and the workpiece surface dissipates at a very low rate eventually leading to work hardening of the material and rapid tool damage. Also in any turning operation, cutting forces have always influenced the deformation and the dimensional accuracy of the workpiece being machined [6]-[8]. It is inferred through [4]-[8] that the work hardening, tool contact deterioration and the subsequent build-up of pressure at the tool contact area may lead to further deflection of the workpiece away from tool surface resulting in dimensional instability and poor surface finish. Numerous researches have been carried out to achieve dimensional stability by manipulating the machining variables [9]-[13]. The application of statistical DOE to analyse the magnitude of relationships between variables and their responses in machining, is widely proven in past researches[14]-[15]. In this study, an attempt is made to evaluate the effects of the low elastic modulus of

Ti6Al4V over the dimensional instability, surface roughness, and the tool wear in a CNC turning process through a designed set of experiments. The results of this study is interpreted in the form of logical expressions that define the influence of the low elastic modulus of Ti6Al4V and the manipulated machining variables, namely, cutting depth, feed rate, tool wear and cutting force on the post-machining dimensions achieved.

Simulative analysis indicates that the dimensional instability will be greater when the cylinder is machined in a ‘cantilever’ mode in the lathe depending upon the overhang ratio of the workpiece, which has been experimented to be a significant factor that induces vibration in a turning process leading to deflections [16]. These deflections tend to push the cylinder away from the force applied when subjected to cutting load as shown in Fig 1.

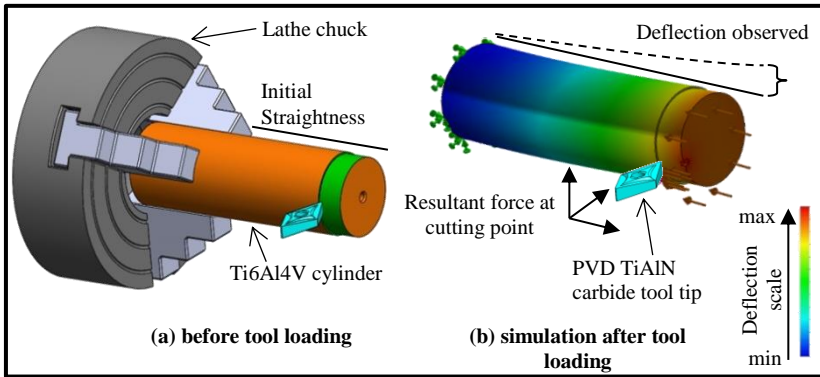

Figure 1: Deflection of workpiece observed in a Cantilever set-up

Titanium Alloy Ti6Al4V has a hardness of 36 on Rockwell C scale (334 BHN) and hence, is considered as a hard to machine material. Also, due to its low thermal conductivity, heat build-up concentrates at the tool contact area and due to the slow dissipation rate, rapidly damages tool tips [17].

## Methodology

### Experimental Set-up

For an authentic projection of results, this experimental set up uses a ‘simply supported mode’ where the Ti6Al4V cylinder is held in between the chuck and a live center at the Tail stock as in Figure 2.

This kind of set up exhibits a flection, where the material is held between two supports and force is applied on the material in between the two supports. The mechanical property that takes effect over here is flexural

elasticity. The magnitude of elasticity - compliance - depends on the structure of the model being examined as shown in Figure 3

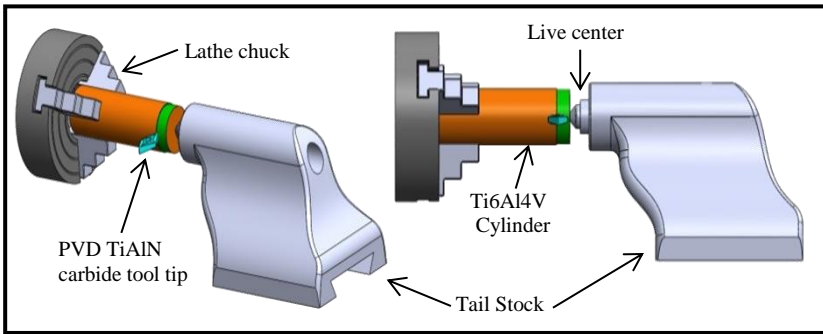

Figure 2: Experimental Set up Applied (in-between chuck & centre)

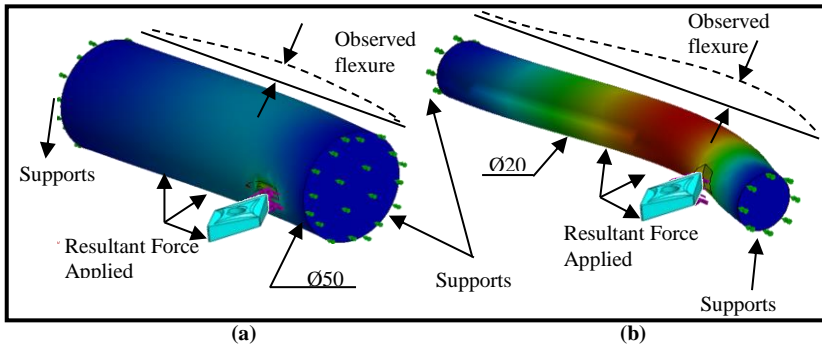

Figure 3: Simulated flexure on (a) Ø50 mm and (b) Ø20 mm cylinders

### Cutting Tool selection

Due to the excessive heat buildup at the tool-workpiece intersection, machining on TiAl64V can be carried out only with cutting tools that have high heat resistance. Hence PVD Carbide Coated TiAlN tool tips are used in this study. TiAlN coated carbide tips have proven to be durable under high temperatures and also known for its ability to perform at high hot hardness and its resistance to oxidation [18].

The coating is applied through a Physical Vapour Deposition Process in which the Metal is evaporated and then a reactive gas under high vacuum and temperature conditions compounds with the metal and forms a 3µm hard and temperature resistant layer on the cutting tool [19]. The nose radius (RE) is R0.40 mm with a straight flank (0°)

### **Hypotheses generation**

Levels of parameters recommended by previous researchers and material manufacturers for Ti6Al4V have been used in this study in order to measure the dimensional instability caused due to the elastic modulus of the material. It is necessary to study whether there is a pattern in the dimensional instability while running under low to higher levels of parameter combinations. It is equally important to prove either of the hypothesis statements, as has been inferred through previous researches [4, 5]:

*'Low elastic modulus of Ti6Al4V causes dimensional instability on turned Ti6Al4V cylinder'*

(OR)

*'Rapid tool cutting edge wear causes dimensional instability on the turned Ti6Al4V cylinder'*

Determining the results of the above hypotheses is essential to pave way for further study on controlling the instability, either by designing solutions to reduce the flexural bend during turning or by optimising the right combination of parameters in order to reduce the flexure. Efficient tool geometry selection and tool compensation methods also can be formulated in order to curb this effect.

### **Experimental Design**

The manipulated variables are the cutting speed, the feed rate and the depth of cut. The above three factors are assigned three levels each to design a 'three factor, three level' experiment ( $3^3$ ) as shown in Table 1. Three replicates of each experiment are carried out to prevent the influence of noise factors. All the experiment runs are carried out with flood dispensation of coolant. Fuchs Ecocool 68CF2 chlorine free [20] cutting fluid is used as the coolant here. Past studies have discovered hot-salt stress corrosion damage in machined Titanium alloys subjected to chlorinated cutting fluids. They eventually tend to crack during secondary cleaning and heat treatment processes [21].

A  $3^3$  general full factorial design is created which, produces 27 experiment runs. In order to reduce or eliminate noise variables, the entire experiment is replicated thrice and the averages of all the measurements are recorded as shown in Table 2.

Table 1: Machining Variables and Responses

Factors Levels	Manipulated Variables			Measured Responses			
	$v$ ( <i>m/min</i> )	$f$ ( <i>mm/rev</i> )	$a_p$ ( <i>mm</i> )	$VB_C$ ( <i>mm</i> )	$N_{i(c)}$ ( <i>mm</i> )	$\overline{\Delta D}$ ( <i>mm</i> )	$R_a$
1	40	0.05	0.4	?	?	?	?
2	55	0.15	0.8	?	?	?	?
3	80	0.25	1.1	?	?	?	?

$v =$  cutting speed ( $x_1$ )

$f =$  feed ( $x_2$ )

$a_p =$  depth of cut ( $x_3$ )

$N_{i(c)} =$  nose wear ( $y1$ )

$VB_C =$  flank wear ( $y2$ )

$\Delta D =$  dimensional variance( $y3$ )

$R_a =$  average roughness( $y4$ )

(Designations in accordance with ISO3685)

Table 2: Experimental Design & Observed Responses

Exp. Run No.	$v$ ( <i>m/min</i> )	$f$ ( <i>mm/rev</i> )	$a_p$ ( <i>mm</i> )	$\overline{\Delta D}$ ( <i>mm</i> )	$\overline{VB_C}$ ( <i>mm</i> )	$\overline{N_{i(c)}}$ ( <i>mm</i> )	$\overline{R_a}$ ( $\mu$ )	F (N)
1	40	0.05	0.4	0.33	0.19	0.012	0.30	48
2	40	0.05	0.8	0.20	0.16	0.015	0.21	96
3	40	0.05	1.1	0.37	0.15	0.019	0.20	132
4	40	0.15	0.4	0.37	0.23	0.010	1.96	144
5	40	0.15	0.8	0.33	0.18	0.013	1.91	288
6	40	0.15	1.1	0.37	0.14	0.014	1.87	396
7	40	0.25	0.4	0.33	0.15	0.012	2.39	240
8	40	0.25	0.8	0.40	0.29	0.013	2.03	480
9	40	0.25	1.1	0.30	0.32	0.018	2.47	660
10	55	0.05	0.4	0.40	0.13	0.011	0.16	48
11	55	0.05	0.8	0.37	0.12	0.012	0.32	96
12	55	0.05	1.1	0.30	0.14	0.016	0.25	132
13	55	0.15	0.4	0.37	0.15	0.010	1.92	144
14	55	0.15	0.8	0.33	0.16	0.012	1.70	288
15	55	0.15	1.1	0.27	0.14	0.015	1.84	396
16	55	0.25	0.4	0.37	0.11	0.014	2.39	240
17	55	0.25	0.8	0.43	0.20	0.016	2.29	480
18	55	0.25	1.1	0.37	0.22	0.017	2.30	660
19	80	0.05	0.4	0.30	0.15	0.012	0.26	48
20	80	0.05	0.8	0.33	0.12	0.017	0.25	96
21	80	0.05	1.1	0.40	0.16	0.018	0.26	132
22	80	0.15	0.4	0.33	0.12	0.011	1.87	144
23	80	0.15	0.8	0.27	0.14	0.017	1.89	288

24	80	0.15	1.1	0.33	0.17	0.019	1.70	396
25	80	0.25	0.4	0.30	0.13	0.013	2.30	240
26	80	0.25	0.8	0.37	0.23	0.016	1.77	480
27	80	0.25	1.1	0.33	0.21	0.020	2.25	660

### Tool wear & workpiece measurements

The workpiece diameter is measured using a digital caliper with a  $1\mu$  least count. The tool wear is also inspected for qualitative deterioration (BUE, crater formation, chip off etc.) and quantitative wear (flank wear  $VB_C$ , nose wear  $N_{i(c)}$ ) using a toolmaker’s microscope. The caliper for diametric measurements and toolmaker’s microscope for the tool wear measurement have been calibrated prior to their use. Hence, they do not contribute to the variations observed between the intended and actual measurements. The cutting force ‘F’ applied by the tool on the cylinder during the cutting process is calculated using Equation (1) [22].

$$\text{Cutting force, } F_c = K_c \times d \times f \quad (1)$$

where  $K_c$  is the specific cutting force coefficient.  $K_c$  of Ti6Al4V is  $2400 \text{ N/mm}^2$  [23].

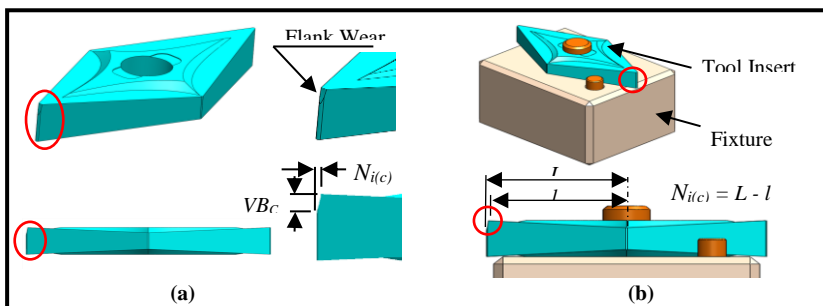

Figure 4: (a) flank wear  $VB_C$  & nose wear  $N_{i(c)}$ ; (b) measuring fixture

The tool nose wear and wear along the flank band width are measured with the help of an inspection fixture on a tool maker’s microscope as shown in Figure 4. It is essential to evaluate if there has been sufficient tool wear to cause the magnitude of variance in the dimensions or whether it is due to the elastic deflection of the specimen upon applying the cutting load, as represented in Figure 5. The dimensional variance, tool wear magnitudes and the surface roughness readings observed are shown in Table 2.

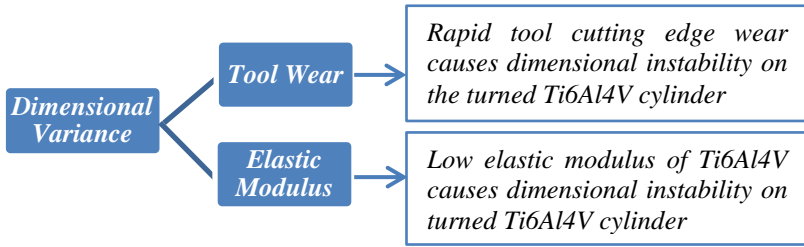

Figure 5: Key attributes of Dimensional Variance in turning operation

## Results and Discussion

The results measured have been summarized as shown in Table 2. It is observed that the average nose wear ranges between 0.01 mm ~ 0.02 mm, which can only produce dimensional variances ranging from  $\emptyset 0.02$  mm ~  $\emptyset 0.04$  mm. However,  $\Delta D$  ranging from 0.20 mm ~ 0.43 mm is observed on the diameter of the cylinder, which indicates that the;

$$\text{Actual material removal} < \text{Intended material removal by } \emptyset 0.20 \sim (2)$$

This implies that the observed average dimensional variance on the cylinder, according to Eq.1 is about 12 times that of what could have been caused by the average tool nose wear.

$$\emptyset \overline{\Delta D} = \frac{1}{27} \sum_{i=1}^{27} \Delta D = 12 \times 2(\overline{Nt(c)}) \quad (3)$$

The flank wear does not directly cause the dimensional variance on the part. It only provides a qualitative information on the vertical wear at the tool edge which is straight here. It is also noted through a qualitative inspection that the tool tips are not damaged or worn off (blunt), which could have lead to enormous burnishing force further deforming the material.

This phenomenon of drastic increase in the cutting force by worn out tools has been discussed in past researches. It has also been stated that an increase in the cutting force will further deteriorate the tool, thus causing an interdependent cyclic effect between the tool wear and cutting force contributing to more imprecision. A dynamic degradation of the surface is also caused by increased cutting forces, which have been observed to be the primary cause of workpiece deflections [24, 25]. Statistical analysis carried out between factors and responses using MINITAB is tabled below and plotted in Fig 6 .



### Statistical Analysis

A statistical analysis of the ‘factors to responses’ and ‘responses to responses’ is conducted using MINITAB whose results have been illustrated in Table 3 and also plotted in Figure 6 .

In Table 3., the **analysis group A** indicates that the depth of cut is directly proportional to the cutting force and both the above are individually and in interaction positively correlated to tool nose wear and the flank wear. However, according to the **analysis group B**, the tool nose wear and flank wear shows poor correlation to the dimensional variance, hence are considered insignificant as proven earlier by the *Eq.3*.

**Analysis C** also indicates a poor correlation between the dimensional variance and resultant cutting force and is again insignificant, presumed to be due to the compliance of the specimen used - Ø50 mm - in the experiment, to the resultant cutting force.

Conceivably, in the case of a specimen of Ø20 mm, the elastic deflection would be relatively greater causing a larger degree of variance in the dimensions. This fact has been experimentally proven in past researches, wherein thermo-mechanical loads have been attributed to the workpiece deflections or deformations in a turning operation and the difference in the diameter of the workpiece causes difference in the percentage of deflection in the workpiece [26].

Table 3: Correlation & significance statistics

(Direction of the arrows ‘→’ signify trend in correlation if positive, negative or insignificant)

X's	Y's	Y's	Correlation Value (-1 ~ +1)	Significance (P)
<b>Analysis Group A</b>				
<b>Depth of Cut</b>	Nose Wear	-	0.80 (→ +1)	0.000 Significant
	<b>Depth of Cut</b>	Cutting Force	0.54 (→ +1)	0.004 Significant
-	Cutting Force	Nose Wear	0.51 (→ +1)	0.007 Significant
-	Cutting Force	Flank wear	0.64 (→ +1)	0.000 Significant
<b>Analysis Group B</b>				
-	Nose Wear	Avg. Dim. Variance	-0.10 (→ 0)	0.602 Insignificant
-	Flank Wear	Avg. Dim. Variance	0.16 (0 ←)	0.43 Insignificant
<b>Analysis C</b>				
-	Cutting Force	Avg. Dim. Variance	0.12 (0 ←)	0.567 Insignificant

Further analysis show that regardless of the magnitude of depth of cut, cutting speed and tool wear,  $R_a$ , is seen to vary positively with regard to variance in the feed rate, which has been plotted in Figure 7. It is observed that, for all the levels of cutting speed and depths of cut, the line graph depicting surface roughness is at the minimum whenever the feed rate is at the minimum level and maximum at higher levels of feed rate.

When the feed rate ‘ $f$ ’ (orange line) is at 0.05mm/rev and the cutting speed ‘ $v$ ’ is 40m/min, at all the three depths of cut ‘ $a_p$ ’, the surface roughness ‘ $R_a$ ’ is observed to be less than  $0.05\mu$ . As the feed rate ascends to the next two levels of 0.15mm/rev and 0.25mm/rev respectively, under the same cutting speed of 40 m/min, a proportional increase in  $R_a$  is observed.

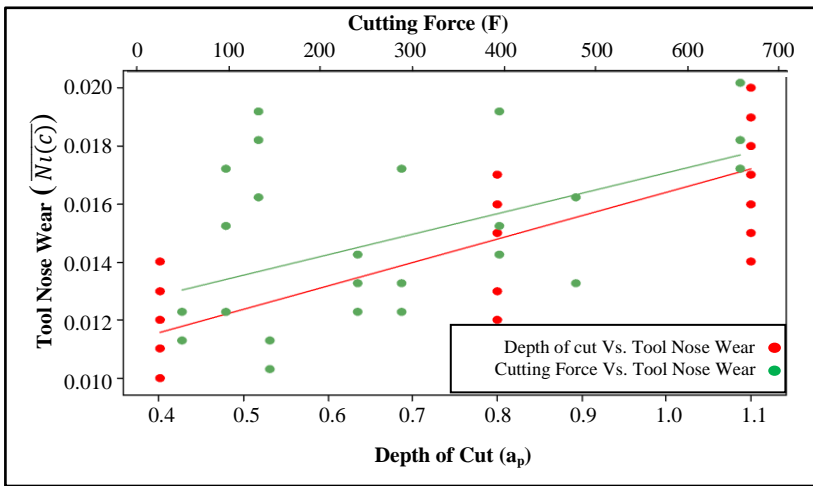

Figure 6 Correlation Plot - F &  $a_p$  over  $\overline{Nl(c)}$

The same trend is noticed when the experiment starts all over again, this time with greater cutting speeds of 55m/min and 80m/min. It is observed that though the cutting speeds change, the values of  $R_a$  under the different depths of cut are almost aligned in the same line as shown by the trend lines indicated by the dashed lines of their respective colours.

These results are backed up by past studies wherein a direct proportion has been established between feed rate and surface roughness. It has also been stated that the surface roughness decreases upon increase in cutting speeds and depth of cut [27], which can also be noted to an extent in Fig.7.

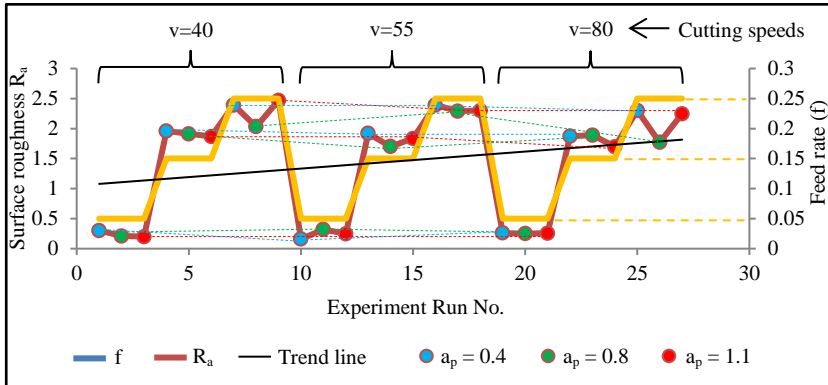

Figure 7: Scatter Plot – Feed rate Vs. Surface roughness

## Conclusions and Recommendations

The influence of its low elastic modulus which is further aggravated by the depth of cut and the generated cutting force contributes to between 25 - 40 % of residual stock on the diameter of a cylinder after a turning cut is taken on Ti6Al4V material in a lathe set-up, where the cylinder is supported at both the ends. The diameter of the specimen also reserves its right on the amount of elastic flexure caused when the cutting load is applied. Here a dimensional variance of  $\text{Ø}0.20 \sim \text{Ø}0.43$  has been observed. An experimental comparison of the above results with specimens of  $\text{Ø}20$  and  $\text{Ø}30$  would provide more stable justification on the effect of flexural elastic modulus on the dimensional instability in CNC turning of Ti6Al4V depending on the cross section of the specimen. Also a comparative study on different materials with higher and lower modulus of elasticity than Ti6Al4V can be tested for confirmation of the results. Tool geometry influences the cutting efficiency, which may in turn reduce the cutting force generated. However, sharper tool tips will rapidly wear off or get chipped off while machining hard materials like Ti6Al4V. Hence a balanced design of tool tip radius & relief angles has to be optimized in order to reduce or eliminate the effects of Elastic modulus on the dimensional instability in machining of Ti6Al4V and also to produce better surface finish on the machined workpiece.

## References

- [1] S. Suresh, M. A. Jamil, S. Sulaiman, and M. R. M. Shokor, "Optimization of Electrode Material for EDM Die-sinking of Titanium Alloy Grade 5-Ti6Al4V," *International Journal on Advanced Science, Engineering and Information Technology* 6(4), 534-539 (2016).

- [2] C. Oldani, A. Dominguez, T. Eli , “Titanium as a Biomaterial for Implants”, (INTECH Open Access Publisher, 2012).
- [3] X. Yang and L. C. Richard, “Machining Titanium and its Alloys,” *Machining Science and Technology*, 3(1), 107-139 (1999).
- [4] *Titanium Machining Guide, Kennametals*.
- [5] J. F. Kahles, M. Field, D. Eylon, and F. H. Froes, “Machining of Titanium Alloys,” *JOM*, 37(4), 27-35. (1985). doi: 10.1007/BF03259441.
- [6] C. Veiga, J. P. Davim, and A. J. R. Loureiro, “Review on machinability of titanium alloys: the process perspective,” *REVIEWS ON ADVANCED MATERIALS SCIENCE*, 34(2), 148-164 (2013).
- [7] H. Su, P. Liu, Y. Fu and J. Xu, “Tool Life and Surface Integrity in High-speed Milling of Titanium Alloy TA15 with PCD/PCBN Tools,” *Chinese Journal of Aeronautics*, 25(5), 784-790 (2012).
- [8] R. R. Malagi, and B. C. Rajesh, “Factors Influencing Cutting Forces in Turning and Development of Software to Estimate Cutting Forces in Turning,” *International Journal of Engineering and Innovative Technology (IJEIT)*, 2, pp.37-43 (2012).
- [9] M. V. Ribeiro, M. R. V. Moreira, and J. R. Ferreira, “Optimization of titanium alloy (6Al-4V) machining,” *Journal of Materials Processing Technology*, 143-144(0), 458-463 (2003).
- [10] D. K. Chauhan and K. K. Chauhan, “Optimization of Machining Parameters of Titanium Alloy for Tool Life,” *Journal of Engineering Computers & Applied Sciences*, 2(6), 57-65 (2013).
- [11] S. Abdulkareem, U. J. Rumah, and A. Adaokoma, “Optimizing Machining Parameters during Turning Process,” *International Journal of Integrated Engineering*, 3(1), 23-27 (2011).
- [12] C. R. Dandekar, Y. C. Shin, and J. Barnes, “Machinability improvement of titanium alloy (Ti-6Al-4V) via LAM and hybrid machining,” *International Journal of Machine Tools and Manufacture*, 50(2), 174-182 (2010).
- [13] G. A. Ibrahim, C. C. Haron and J. A. And Ghani, “The effect of dry machining on surface integrity of titanium alloy Ti-6Al-4V ELI,” *Journal of Applied Sciences*, 9(1), 121-127 (2009).
- [14] S. Suresh, A. L. Moe, N. B. Ahmad, and S. B. Sulaiman, “Experimental Study on the Determinants of Surface Finish in Automated Polishing of Moulds,” In *Applied Mechanics and Materials*, Vol. 664, pp. 122-127 (2014).
- [15] S. Suresh, A. L. Moe, and A. Abu, “Defects Reduction in Manufacturing of Automobile Piston Ring Using Six Sigma,” *Journal of Industrial and Intelligent Information Vol*, 3(1) (2015).
- [16] C. O. Izelu, S. C. Eze, B. U. Oreko, B. A. Edward, and D. K. Garba, “Response surface methodology in the study of induced machining

- vibration and work surface roughness in the turning of 41Cr4 alloy steel,” *Int J Emerg Technol Adv Eng*, 3, 13-17 (2013).
- [17] <http://www.aerospacemetals.com/titanium-ti-6al-4v-ams-4911.html>
- [18] N. H. Rafai, M. A. Lajis, and N. A. J Hosni, “Performance of TiAlN-PVD coated carbide tools in milling AISI D2 hardened steels” (2013).
- [19] L. Dobrzanski, M. Staszuk, K. Golombek and A. Sliwa and M. Pancielejko, “Structure and properties PVD and CVD coatings deposited onto edges of sintered cutting tools,” *Archives of Metallurgy and Materials*, 55(1), 187-193 (2010).
- [20] FUCHS. (n.d.). *Product Information* [Brochure]. Mannheim: Author. PI 1-0180e, Page 1/ Freiler/ 07.07.
- [21] M. J. Donachie, *Titanium: a technical guide*. ASM international (2000).
- [22] J. S. Jadhav, and B. R. Jadhav. “Experimental Study of Effect of cutting parameters on cutting force in turning process,” *International Journal of Innovative Research in Advanced Engineering* 1.6, 240-248 (2014).
- [23] M. Armendia, A. Garay, L. M. Iriarte, and P. J. Arrazola, “Comparison of the machinabilities of Ti6Al4V and TIMETAL® 54M using uncoated WC–Co tools,” *Journal of Materials Processing Technology*, 210(2), 197-203 (2010).
- [24] M. A. Kamely, and M. Y. Noordin. “The impact of cutting tool materials on cutting force,” *World Academy of Science, Engineering and Technology* 51, 903-906 (2011).
- [25] Y. Chou, M. M. Barash and C. Evans, “Finish performance and wear mechanism of cubic boron nitride tools in the turning of hardened 52100 steels,” *Proceedings of the Ceramic Industry Manufacturing Conference and Exposition*, Pittsburgh, PA. (1995).
- [26] M. Zimmermann, S. Schindler, P. Steinmann, and J. C. Aurich, “Compensation of Thermo-mechanically Induced Workpiece and Tool Deformations during Dry Turning,” *Procedia CIRP*, 46, 31-34 (2016).
- [27] S. Ramesh, L. Karunamoorthy, and K. Palanikumar. “Surface roughness analysis in machining of titanium alloy,” *Materials and Manufacturing Processes* 23, no. 2 174-181. (2008).