

Dual-Band Bandpass Filter with Rectangular Shaped Defected Ground Structure

Azliana Binti Abu Kassim
 Faculty of Electrical Engineering
 Universiti Teknologi MARA (UiTM), 40450 Shah Alam, Malaysia
 chunkieess@hotmail.com

Abstract – This paper proposed a dual-band bandpass filter with rectangular shaped defected ground structure (DGS). The filter and DGS is designed using CST Studio Suite. The size of rectangular DGS is optimised and implemented on the ground plane of the filter at various positions. The optimised size for the DGS is 2mm x 5.2mm. The center frequency f_0 for filter with and without DGS is 1.844GHz. The simulated results of filter with DGS and without DGS obtained are analysed and discussed in this paper.

Keywords — dual-band, bandpass filters, coupled-line, defective ground structure (DGS).

I. INTRODUCTION

Nowadays, microwave components such as antennas, filters and couplers are widely used in microstrip technology especially for satellite, microwave communication and wireless communication. In the last few years, many researchers have been working on significant improvements to achieve small-scaled microwave circuits in this modern communication system. In order to make the filter compact, one of the methods is to incorporate the Defected Ground Structure (DGS) technology in the filter design. By using this technique as shown in [1], the size of the filter became more compact compared to other ultra-wideband bandpass filters (UWB BPFs).

DGS is an etched non-periodic or periodic cascaded configuration defect in ground of a planar transmission line which disturbs the shield current distribution in the ground plane [2]. Therefore, any defected etched area on the ground plane of the microstrip will give an effect to increasing effective capacitance and inductance. As shown in figure 1 below, there are variety design of DGS shapes such as spiral head, ‘H’ shape, open loop dumbbell, arrowhead-slot,

interdigital DGS and a square open loop with slots in the middle.

Figure 2 is the topology of the dual-band bandpass filter. It consist of characteristics impedances of transmission line which is Z_r , odd-mode, Z_{ro} and even-mode, Z_{re} and it is connected to a quarter wavelength transmission line.

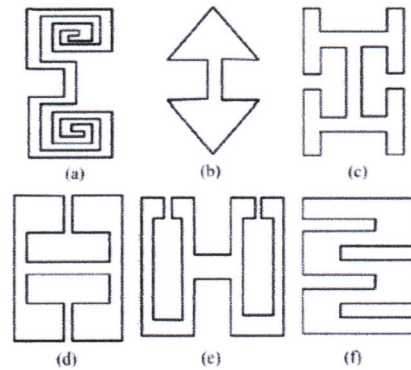

Figure 1: Various DGS shapes: (a) Spiral head (b) Arrow head (c) H shaped (d) A square open loop with slots in the middle (e) Open loop dumbbell (f) Interdigital DGS [4]

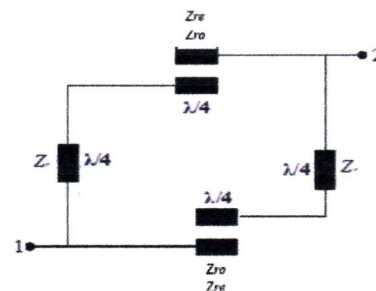

Figure 2: Proposed topology of the dual-band bandpass filter [10]

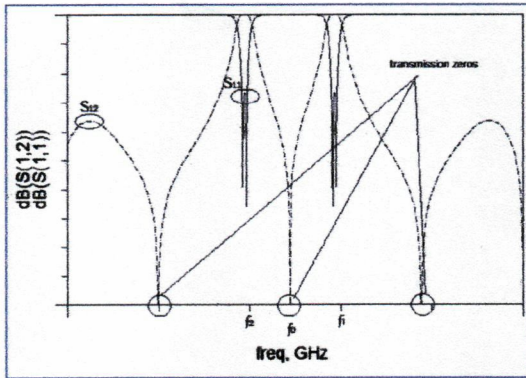

Figure 3: Idle frequency response of dual-band bandpass filter.[10]

Figure 3 above shows the frequency response of the filter without any DGS. It shows a deep and sharp rejection region outside of the symmetrical passband resulting in a dual-band response. The centre frequency, f_0 , acts as the reference frequency and is situated between the two passbands. For the other two passbands, the centre frequency is denoted as f_1 and f_2 , resulting in three transmission zeros that will ensure a good selectivity between the frequencies.

Based on the previous studies in [12], a rectangular shaped DGS was designed to enhance the response of an existing design of a dual-band bandpass filter topology. However, the measured results of the filter with the DGS unit cell achieved were relatively poor compared to their simulated results. The author had attributed this to the relatively high loss tangent of the substrate. In this research, an investigation into this problem will be carried out and a rectangular shaped DGS also was implemented. Various dimensions and positions of the DGS unit cell will be studied and the performance of the filter were analysed. It is envisaged that the DGS unit cell will be analysed systematically between the parallel-coupled lines to attain the best performance in terms of improved return loss and outer rejection bands. A comparison between the filter with DGS and without DGS will also be observed.

II. METHODOLOGY

In this chapter, the research process will be discussed in detail to achieve the research objectives.

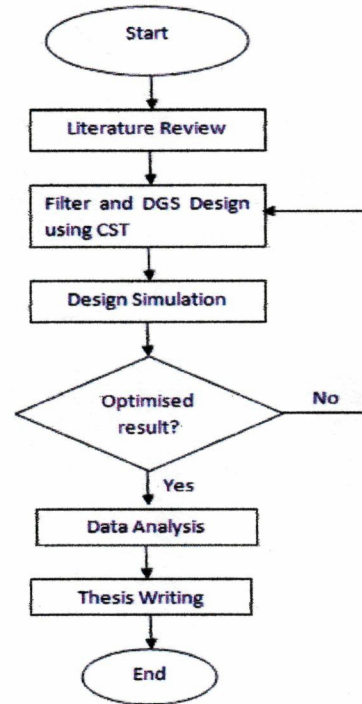

Figure 4: Flowchart for dual-band bandpass filter design

From figure 4 above, the flowchart shows the steps in designing a dual-bandpass filter with rectangular shaped DGS. The filter and DGS is designed by using CST Studio Suite software. The length and width of transmission line and coupled line were optimized to get an ideal frequency response in S_{11} and S_{21} simulation graph. The rectangular shaped DGS are placed in some different point and the results obtained are studied. All frequency response results are analysed.

III. DESIGN OF DUAL-BAND BANDPASS FILTER

Figure 5 below shows the optimised dimension of dual-band bandpass filter layout. The filter used FR-4(lossy) for the substrate where the substrates thickness, $h = 1.6$ mm, copper thickness is 0.035 mm, relative dielectric constant, $\epsilon_r = 4.3$, and loss tangent, $\tan \delta = 0.025$.

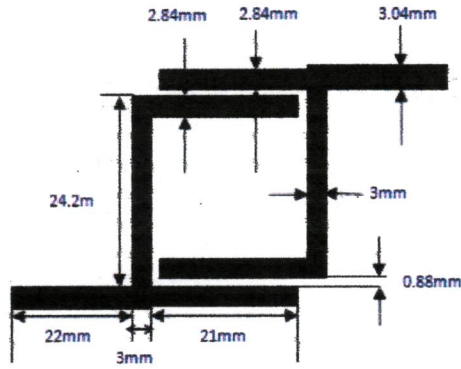

Figure 5: 2D circuit layout of the dual-band bandpass filter.

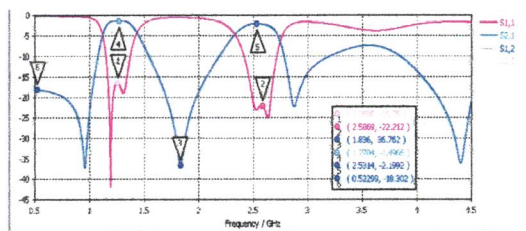

Figure 6: Simulated result for filter without DGS

Figure 6 shows that two passband centered at 1.2588 GHz (f_1) and 2.5869 GHz (f_2) respectively obtained. The S11 for the first passband is deeper compared to the second passband where the maximum return loss value is nearly 43 dB. The isolation level between the two passband centered at 1.836 GHz (f_0), achieved more than 30 dB which is at 36.762 dB. The range frequency for this filter is 0.962 GHz to 2.873 GHz. The first outer rejection band is nearly 20 dB. The insertion loss S21 in the first passband is 1.4966 dB while at the second passband is at 2.1992dB. The 3dB-bandwidth for the first passband is 321 MHz while the value for second passband is 428 MHz.

IV. DESIGN OF DUAL-BAND BANDPASS FILTER WITH RECTANGULAR SHAPED DGS

The proposed DGS shape for this dual-band bandpass filter is rectangular shape. The rectangular DGS are optimised by using 3 different sizes with width 2mm, 3mm and 4mm, with 5.2mm height. The results are shown as in figure 7 below;

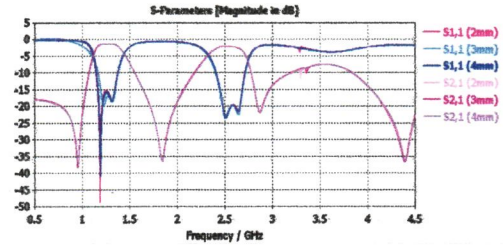

Figure 7: simulated result for 3 different sizes of DGS

Table 1: Results of 3 different sizes of DGS

Height (mm)	Width (mm)	Isolation level at f_0 (dB)	S11 (1 st passband) (dB)	S11 (2 nd passband) (dB)
5.2	2	36.481	16.529	19.472
5.2	3	36.399	15.936	19.225
5.2	4	36.587	15.781	19.784

Referring to figure 7 and table 1 above, we can see the size with width 2mm shows the highest return loss, S11 with 16.529 dB. The first outer rejection band for all sizes is nearly 20 dB. It shows that the optimised dimension for the DGS size give better response when the width is 2mm compared with the other 2 sizes. Therefore, the size used for the DGS is for this filter is 5.2mm x 2mm.

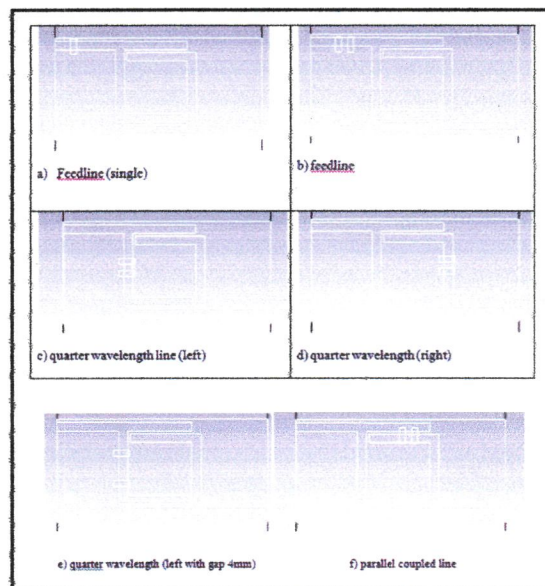

Figure 8: Various position of DGS

Figure 8 above shows various positions of DGS on the ground plane of the filter where the effect of frequency response obtained is analysed.

V. RESULTS AND DISCUSSIONS

A. DGS on quarter wavelength line

Two DGS are placed at the quarter wavelength line with different position as shown in figure 8(c), (d), and (e) above. The results responses are shown as in figure 9 below.

From figure 9 and result table 2 below, we can see that when the DGS is placed at the left side of quarter wavelength line on the ground plane, it gives the most effect on S11 of the filter. The return loss improved about 3.039 dB when the gap of DGS on the left side increased to 4mm with S11 reaching nearly 16.39 dB compared to 2mm DGS gap with S11 at 13.351 dB. The first outer rejection level for 2mm on the left side DGS is at the lowest level with 17.596 dB and its centered frequency is a bit lower than the others.

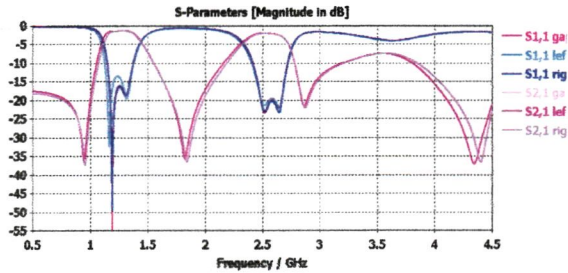

Figure 9: Simulated result for DGS at quarter wavelength line area

Table 2: Results for DGS at quarter wavelength line

Position:	Gap	Isolation	1 st	2 nd
quarter	(mm)	level	passband	Passband
wavelength		at	S11(dB)	S11(dB)
line		fo(dB)		
left	2	35.717	13.351	19.476
right	2	36.599	16.232	20.267
left	4	36.663	16.39	19.926

B. DGS on feedline

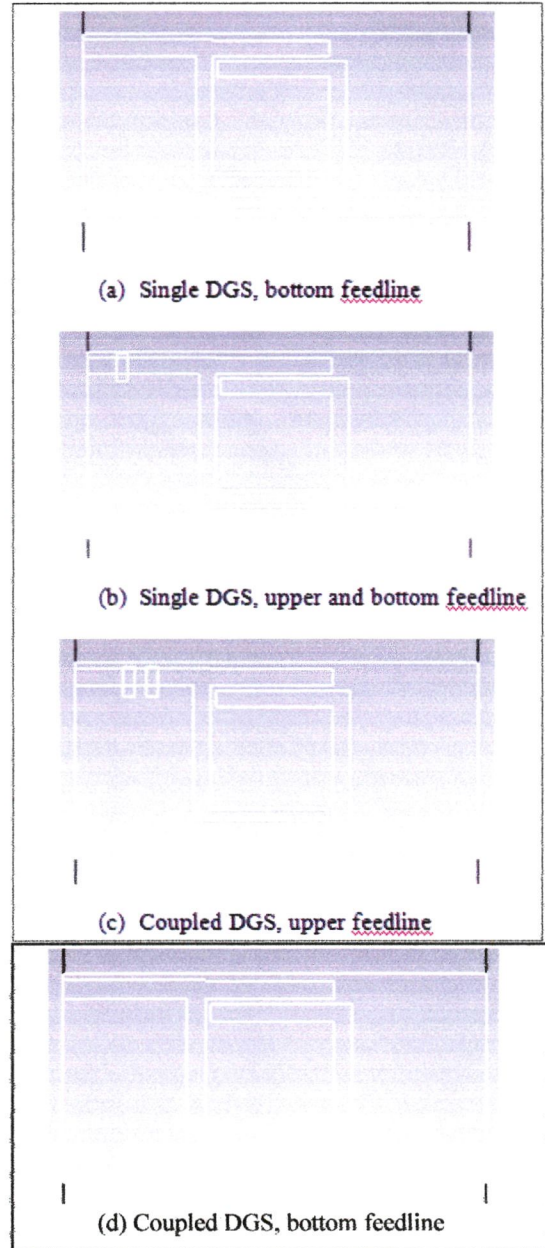

Figure 10: Filter with DGS placed on feedline

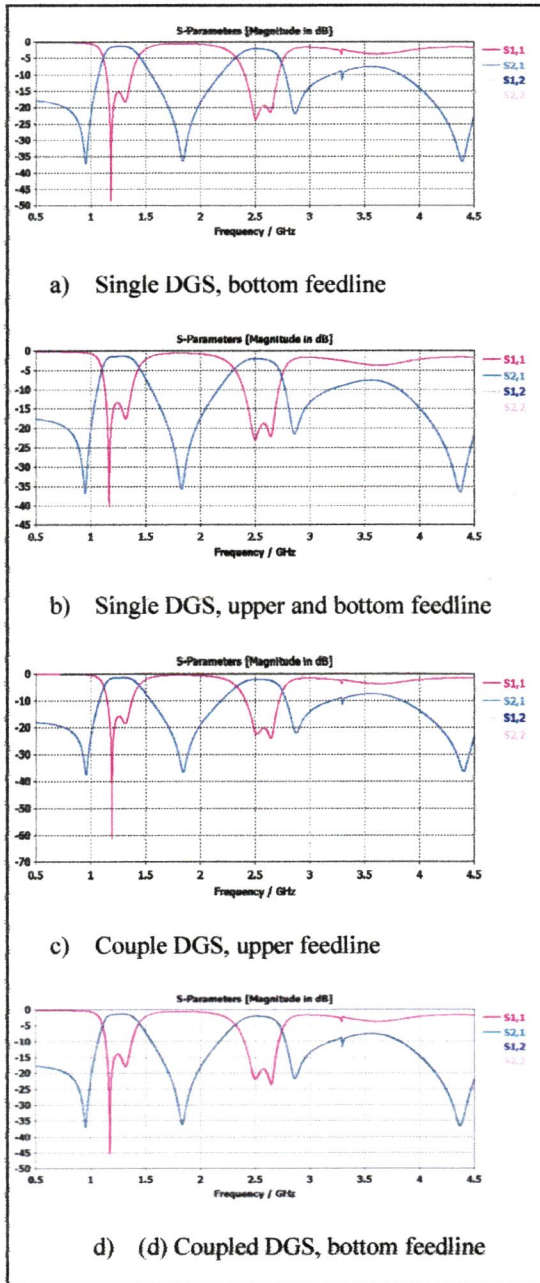

Figure 11: Simulated results for DGS placed on feedline

Table 3: Results for DGS placed on feedline

Position: Feedline	Isolation level at f_o (dB)	1 st passband S_{11} (dB)	2 nd passband S_{11} (dB)
Single DGS, bottom feedline	36.481	15.529	19.743
Single DGS, upper & bottom feedline	35.87	13.432	18.899
Coupled DGS, upper feedline	35.781	12.945	17.714
Coupled DGS bottom feedline	36.481	14.061	18.481

From 4 positions of DGS in figure 11 above, coupled DGS placed on upper feedline is the worst position compared the other three since it has the lowest return loss at 12.945 dB (S_{11} 1st passband). Single DGS at bottom feedline have the highest return loss with 19.743 dB (S_{11} 2nd passband) and 15.529 dB return loss in 1st passband. It is about 2.584 dB improvement of S_{11} in 1st passband compared to single DGS at the upper and bottom feedline. However, when single DGS is at the upper and bottom feedline, the harmonic distortions disappeared. The first outer rejection band and isolation levels for all 4 positions above are nearly the same.

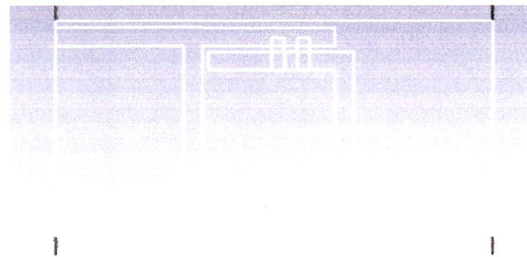

Figure 12: DGS on parallel coupled line

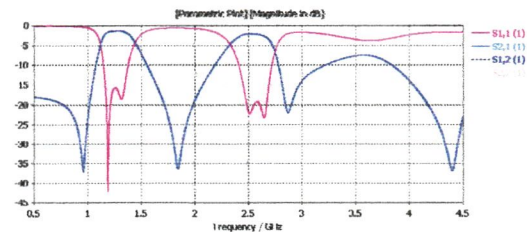

Figure 13: Simulated result for DGS on parallel coupled line

When the coupled DGS is placed on parallel coupled line as shown in figure 13 above, the isolation level obtained is 36.487 dB centred at f_0 , 1.844 dB as shown in frequency response simulated graph in figure 4.6 above. The return loss for the first passband is 15.953 dB, improved nearly 3.377 dB compared to the second passband at 19.33 dB. No harmonic distortion for DGS at this position.

VI CONCLUSION

After all position of rectangular DGS placed on the filter and results graph obtained has recorded, comparison and data analysis are executed. Supposed that when a DGS is applied in the filter topology, the frequency response should show some improvements.

Based on results obtains, the results between filter without DGS and filter with DGS does not shows much improvement. The most significant results that can be seen are the steepness point of the passband especially in the 1st passband. It is observed that all of the results obtained give nearly the same outer rejection band and the center frequency which is at 1.836 GHz.

ACKNOWLEDGEMENT

I would like to thank and convey my gratitude to my final year project supervisor, Dr. Muhammad Farid Abdul Khalid for his guidance, support and sharing ideas in helping to complete the final year project and preparing this technical paper. I also would like to thank all my family members.

REFERENCES

- [1] Y. Saini and M. Kumar, "Performance analysis of chebyshev UWB bandpass filter using defected ground structure," *2014 International Conference on Advances in Computing, Communications and Informatics (ICACCI)*, 2014.
- [2] L. Weng, Y. Guo, X. Shi and X. Chen, "An Overview On Defected Ground Structure," *Progress In Electromagnetics Research B*, vol. 7, pp. 173-189, 2008.
- [3] M. Challal, F. Labu, M. Dehmas and A. Azrar, "Comparative Study of Three DGS Unit Shapes and Compact Microstrip Low-Pass and Band- Pass Filters Designs," *World Academy of Science, Engineering and Technology* 59, 2011
- [4] Khan, M.T.; Zakariya, M.A.; Saad, M.N.M.; Baharudin, Z.; Rehman, M.Z.U.; Wong, P.W., "Tuning of end-coupled line bandpass filter for 2.4 GHz using defected ground structure (DGS) parameters," in *Business Engineering and Industrial Applications Colloquium (BEIAC)*, 2013 *IEEE*, pp.131-134, 7-9 April 2013
- [5] Khan, M.T.; Zakariya, M.A.; Saad, M.N.M.; Baharudin, Z.; Ur Rehman, M.Z., "Analysis and realization of defected ground structure (DGS) on bandpass filter, in *Intelligent and Advanced Systems (ICIAS)*, 5th International Conference 2014, pp. 1-4, 3-5 June 2014
- [6] Khan, M.T.; Zakariya, M.A.; Saad, M.N.M.; Baharudin, Z.; Rehman, M.Z.U., "Parametric effect of defected ground structure (DGS) on frequency of a bandpass filter," in *RF and Microwave Conference (RFM)*, 2013 *IEEE International*, pp.184-188, 9-11 Dec. 2013
- [7] Othman, M.A.; Mohd Ijtihad, N.A.; Sulaiman, H.A.; CheSeman, F "Parametric studies on effects of defected ground structure (DGS) for 6 GHz bandpass filter," in *Technology Management and Emerging Technologies (ISTMET)*, 2015

International Symposium on , pp.25-29, 25-27 Aug. 2015

[8] A. Boutejdar, A. Omar, E. Burte and R. Mikuta, 'An improvement of defected ground structure lowpass/bandpass filters using H-slot resonators and coupling matrix method', *Journal of Microwaves, Optoelectronics and Electromagnetic Applications*, vol. 10, no. 2, pp. 295-307, 2011.

[9] Singh, Pragya, and RaghuvirTomar, "The Use of Defected Ground Structures in Designing Microstrip Filters with Enhanced Performance Characteristics," *Procedia Technology* 17: 58-64, 2014

[10] C. Garg And M. Kaur, "A Review Of Defected Ground Structure (Dgs)," *International Journal Of Innovative Research In Electrical, Electronics, Instrumentation And Control Engineering*, Vol. 2, No. 3, Pp. 1285-1290, 2014.

[11] Alburaikan, A.; Aqeeli, M.; Xianjun Huang; Zhirun Hu, "Miniaturized via-less ultra-wideband bandpass filter based on CRLH-TL unit cell," in *Radio and Wireless Symposium (RWS), 2015 IEEE* , pp.126-128, 25-28 Jan. 2015

[12] M. F. A. Khalid, Z. I. Khan, M. K. MohdSalleh, M. R. MohdRuslan and N. A. Wahab, "Dual-Band Bandpass Filter with Rectangular Shaped Defective Ground Structure," *2015 IEEE International RF and Microwave Conference (RFM 2015)*, 14 – 16 Dec. 2015