

DEVELOPMENT OF MOBILE INCUBATOR FOR QUAIL EGG PRODUCTIONS IN MALAYSIA

¹*Fatimah Nur Mohd Redzwan, ¹Nur Idawati Md. Enzai, ¹Mazratul Firdaus Mohd Zin

¹Faculty of Electrical Engineering
Universiti Teknologi MARA (UiTM) Cawangan Terengganu
Kampus Dungun
23000 Dungun, Terengganu, Malaysia

*Corresponding author's email: fatima804@tganu.uitm.edu.my

Submission date: 15 July 2017 Accepted date: 30 Sept 2017 Published date: 30 Nov 2017

Abstract

The purpose of this project is to design and develop the system of a forced-air egg incubator that is able to incubate quail bird, which is called Mobile Quail Egg Incubator System (MQEIS). The main usage of MQEIS is to incubate quail eggs for quail production in Malaysia. This incubator is equipped with temperature and humidity sensor that could measure the condition of the quail egg. Inaccurate control of the incubator could affect the temperature and humidity of the incubator to become higher or lower. In this project, a small bulb is located inside the incubator to provide suitable temperature for the quail eggs. In order to maintain the good condition of humidity and ventilation, the incubator is filled up with small amount of water and controlling fan works as the cooling element to regulate air inside the incubator for the hatching process. The LCD screen display, which is located at the front of incubator machine, will display status condition of the incubator in term of its temperature and humidity. The whole incubator system is controlled by the ArduinoAtMega328p as the main microcontroller. This Arduino microcontroller is programmed to produce the desired output. The humidity sensor (DHT11) is connected to Arduino to detect humidity and temperature, which then will be displayed digitally on 16 x 2 LCD screen. The digital controller (W1209) is then used to control the heating element. The processed data from sensors is simulated by the digital thermostat (W1209) and will be executed by the control element to change the condition of the bulb either turning it on or off. The incubator machine has been tested and achieved suitable temperature and humidity of 38°C and 64% respectively. The prototype of this MQEIS is made from Styrofoam polystyrene due to its light-weight and compact size.

Keywords: ArduinoAtMega328p; quail eggs; incubator; embryo; hatching;

1.0 INTRODUCTION

Nowadays, the demand for production of agriculture and farming fields in Malaysia has increased rapidly. One of the highest requests from Malaysians is the production of quail egg. Quail rearing is growing in Malaysia as farmers increase output to meet high demand in production of quail birds. According to the secretariat of East Coast Economic Region, the interest in quail egg has ascended about 20-25% annually since 1995. Because of that, more engineering technologies are required for the development of agricultural and farming fields especially in quail egg hatching process to sustain the production. Therefore, to achieve this goal, this proposed project is developed with efficient construction and aimed for easy operation. The proposed study aims to develop and build a system of eggs incubator to incubate large number of quail eggs by handling them all simultaneously through a

mobile incubator instead of natural hatching by a single hen. The usage of incubator is popular among the farmers to surge the hatching process of the quail eggs without involving its brooding parent. The major difference between natural and technological incubation is the process where natural parent of birds provides warmth by contact rather than using the surrounding warm air to hatch the egg. Before designing a good incubator system, it is important to identify two important elements such as temperature and humidity condition inside the incubator machine (Ramli, Lim, Wahab, & Zin, 2015). These two factors play vital roles and should be observed thoroughly in detail to obtain better percentage rate of completion for the incubation process.

2.0 LITERATURE REVIEW

Based on the previous studies, there are several types of incubator designed as mentioned in (Obidiwe, Ihekweaba, & Aguodoh, 2014; Desha et al., 2015; Obidiwe et al., 2014). There are three types of incubators, which are manual, semi-automatic or fully automatic (Obidiwe et al., 2014) depending on its application as reported in (Omar, Haris, Hidayat, Ismail, & Seroji, 2016; Okpagu, P. E. & Nwosu, 2016). Basically, forced-air and still-air incubator are implemented in the incubator. Forced-air incubators include fans that can provide virtuous air circulation, while still-air is vice versa. Therefore, force-air type as in (Adegbulugbe, Atere, & Fasanmi, 2013) is widely used due to the ability to circulate the air and maintain the heat level, humidity and the internal content of oxygen. The optimum temperature is different between these two types of incubator which are 37.5 – 39.4°C for still air incubator and 37.5°C for forced air incubators (Romao, Moraes, Teixeira, Cardoso, & Buxade, 2008). In addition, the humidity is also significant in providing sufficient moisture to certify the warm atmosphere of the incubator machine (Agboola, Olaniyi, & Aliyu, 2013). Incorrect setting of humidity and temperature lead to the failure of hatching process of the eggs.

Conventionally, most of the incubators are designed in analogue systems. The stability of temperature and humidity is controlled and monitored manually by human or farmers. This analogue system is quite difficult to be operated and increases the time of hatching process, thus slowing the production of quail eggs. Furthermore, this analogue system also encounters common problems such as premature hatching, late hatching, and piped egg with no hatching, blood rings and dead embryos that occur at primary stage of embryonic growth (Ogunwande, Akinola & Lana, 2015). The premature hatching is due to high temperature, which is more than 40°C, while late hatching is caused by low temperature. Besides, there are two factors that affect the pipe egg hatching which are; unsuitable ventilation and low humidity due to the inadequate moisture of the incubator. Other than that, the blood ring of the eggs' problem occur due to the instability of temperature control (Lourens, Van den Brand, 2005; Ipek I Sahan U, 2015). Lastly, the embryos might die during the primary stage due to the faulty in turning the egg and imprecise ventilation (Romao, Moraes, Silva, Teixeira, & Cardoso, 2010).

Therefore, the objective of this paper is to design, model and develop quail egg incubation and hatching system that is capable to control the stability of temperature and humidity of the incubator within the temperature range of 35 to 40°C. The focus of this project is to develop a cost-effective incubator machine with good operating systems. To achieve this objective, ArduinoAtMega328p microcontroller has been utilized in this project to control and operate the whole systems automatically. This paper is divided into four sections as follows: Section I discusses the introduction of egg incubator for quail eggs. Part II presents the project methodology of the whole system, section III presents and discusses results and overall output of the incubator machine and section IV will summarize the conclusion of this paper.

3.0 METHODOLOGY

3.1 Project Development

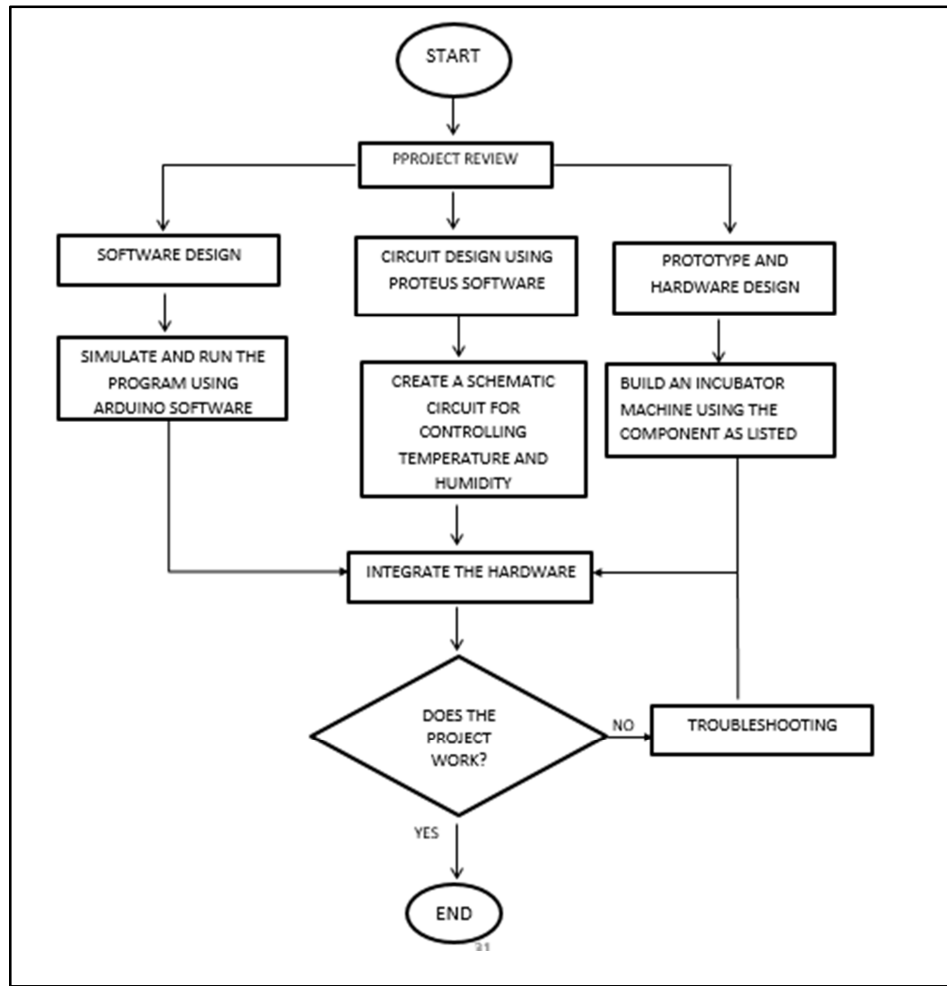

Figure 1 The flow chart of overall project development

Figure 1 above shows the flow chart of overall project development. The project development is divided into three main sections: software design, circuit design, and hardware and prototyping development. In this project, the schematic diagram of the incubator circuit is designed by using the Proteus software. The simulation is run in ISIS software and fabrication part is designed in ARES software to observe whether the circuit could run as programmed. The completed circuit will be converted in ARES to build the Printed Circuit Board (PCB) layout. Then, the circuit will be constructed on (PCB) through the fabrication process. Next, the testing and troubleshooting process will be carried out to identify the operability of the board. Lastly, the circuit design will be integrated with the hardware components to build the prototype. These three sections must be completed successfully to develop, design and model the mobile incubator system for quail eggs.

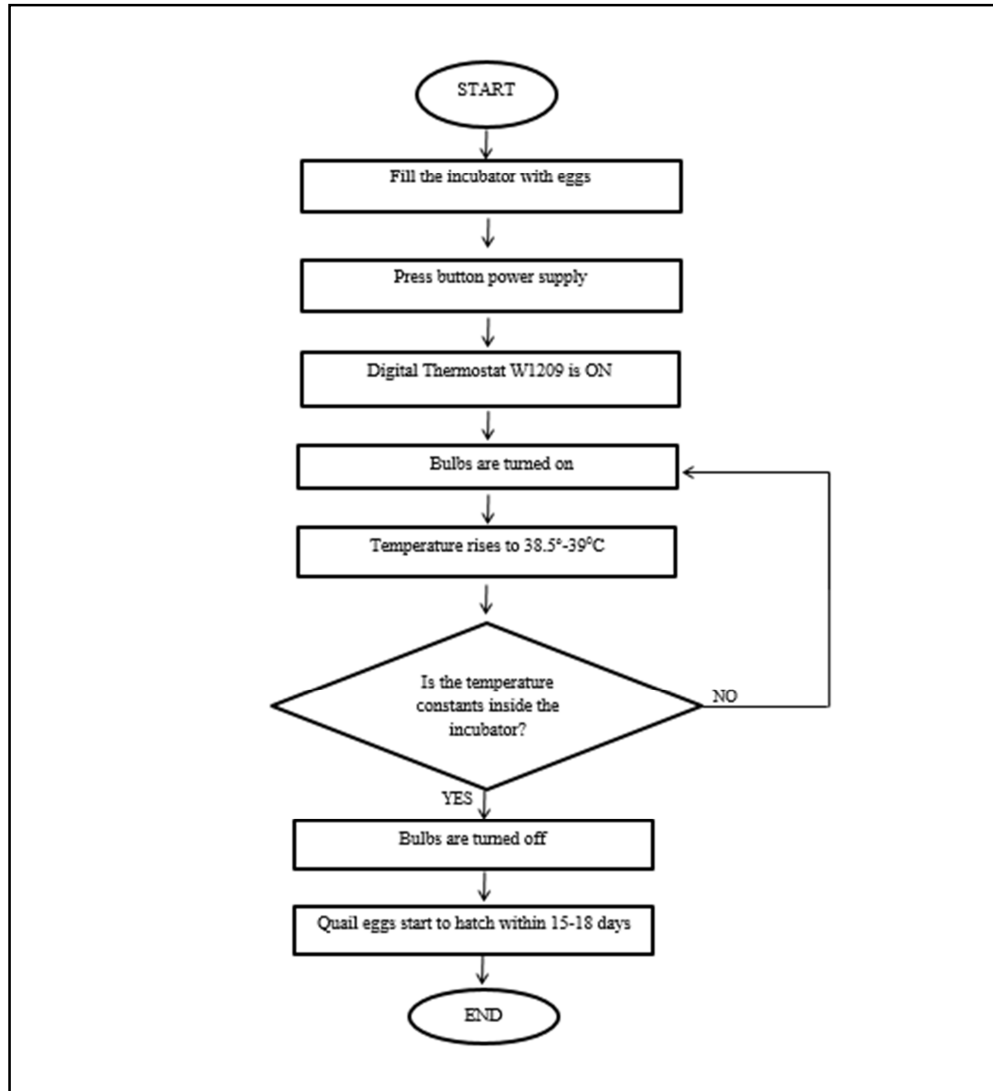

Figure 2 The flow chart of incubator of quail eggs

Figure 2 shows the flow chart of incubator of quail eggs operation. The process started with filling in the incubator with 20 eggs. The eggs need to be arranged inside the static tray that is located inside the incubator machine. After that, the power button is turned on to supply the power to generate the machine. Digital Thermostat W1209 is turned on to heat the eggs until they reach the specified temperature around 38.5°C until 39°. When the temperature increases to 38.5°C until 39°C, the heater will be turned off. If the temperature decreases below 38.5°C, the heater will be turned on again and the eggs will be heated again to the specified voltage. The process will keep going continuously until the all the eggs are hatched. Then, the DC fan will be turned on when the temperature is above 39°C. Next, it will be automatically turned off when the temperature is below 39°C. The range values of the temperature are ± 0.5 °C. This entire hatching process will take about 15 to 18 days until all the eggs are hatching.

4.0 PROJECT DESCRIPTIONS

4.1 List of components used

Table 1 List of components used in incubator of quail eggs

Component	Quantity
Arduino Atmega328p	1
Battery 9V	1
Resistor	3
LCD Display	1
LED	1
Voltage Regulator (5V)	1
Bipolar Capacitor	2
Female Header	4
Battery Holder	1
Potentiometer (10k)	1
Digital Thermostat (W1209)	2
DC Fan	1

Table 1 shows the list of components used in developing the incubator of quail eggs. These components function as the heating element, cooling element and humidity sensor. The details and description of these elements are explained as follows;

A. Cooling Element

A 12V DC fan is connected to the humidity and temperature circuit as an output along with the LCD display. It will function as the cooling element when the temperature rises above the limit. It can also be used as the air regulator inside the incubator since the eggs need sufficient oxygen that is contained inside the surrounding air.



Figure 312V DC Fan

B. Heating Element

The heating element of this project comes from a bulb which will be controlled using a digital temperature controller XH-W1209, and it will turn on and off the output according to the applied setting. Digital Thermostat is used to detect the surrounding temperature and adjust the temperature

according to the series of programmed setting. The entire element will be controlled using Digital Thermostat system (W1209). When the machine is switched on, this indicates that the heater is turned on so that the temperature inside the machine is able to reach the specified temperature which is between 38.5°C to 39°C. When the temperature inside the machine reaches 39 °C, the heater will be turned off and it will be turned on again when the temperature is below 38.5°C. The 12V DC fan is used for security purpose if the circuit malfunctions.

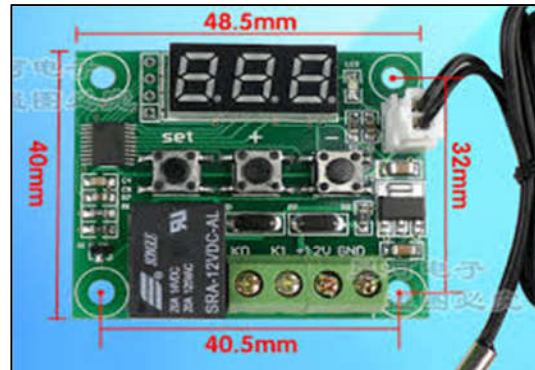

Figure 4 12V Digital Temperature Controller XH-W1209

C. Humidity and Temperature Sensor

Humidity is the amount of water vapour present in the air. Relative humidity (RH) is defined as the ratio of the partial pressure of water vapour (in a gaseous mixture of air and water vapour) to the saturated vapour pressure of water at a given temperature. In this project, DHT11 has been used as the sensor to detect the level of temperature and humidity inside the incubator and then, the results will be displayed on the LCD screen. The percentage of the humidity in the incubator needs to be consistent by controlling the fan and water in the incubator. This is to ensure the humidity and ventilation are around 50-70% for good condition. Digital Thermostat (W1209) displays the temperature reading which indicates the status condition in the incubator. This helps ensuring all part of egg is heated by heater.

5.0 EXPERIMENTAL SETUP AND CIRCUIT IMPLEMENTATION

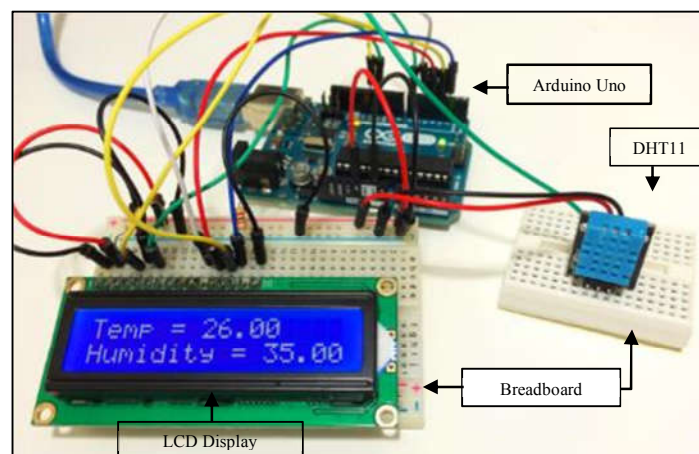

Figure 5 Experimental setup of Incubator of Quail Eggs

Figure 5 shows the completed experimental setup of incubator with humidity sensor which is interfaced to the Arduino ATmega 328P microcontroller board. The circuit consists of Arduino Uno, LCD display, breadboard and DHT11 as the humidity sensor to detect the temperature and humidity level of the incubator. The Arduino programs are burned into Arduino Uno IDE software and a set of instructions have been sent to the microcontroller on the board. Then, the values of temperature and humidity can be monitored through the result display on the LCD screen.

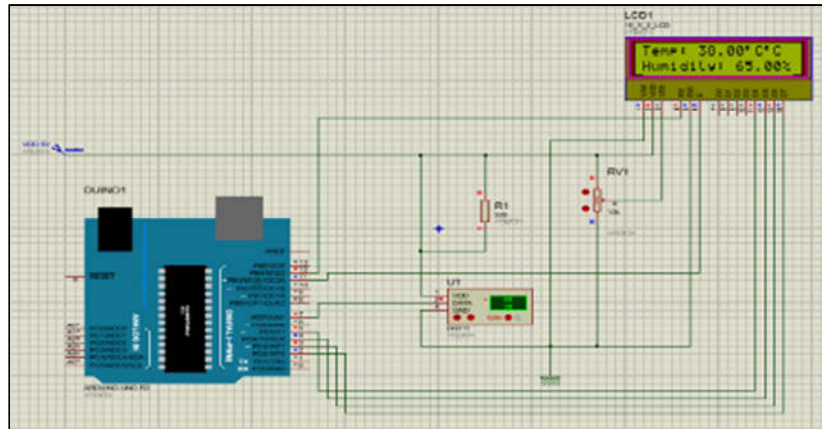

Figure 6 Schematic Diagram of Incubator of Quail Eggs

The schematic diagram of incubator which is designed in Proteus 8.1 software is shown in Figure 6. In this schematic diagram, the Arduino Uno AtMega328p is integrated in this project as the “brain” of the circuit. Arduino is connected with DHT11, which is the temperature and humidity sensor for this circuit. When DHT11 functions, the LCD display as the output will be turned on. The LCD display shows the required information that consists of ‘temperature’ value and ‘humidity’ percentage. The displayed information consists of varying temperature and humidity values. The values may increase or decrease depending on DHT11 sensor. This schematic diagram shows that the simulation results of temperature are 30°C and percentage of humidity is 65%, which tally with the criteria of perfect condition for the incubator.

6.0 RESULTS AND DISCUSSION

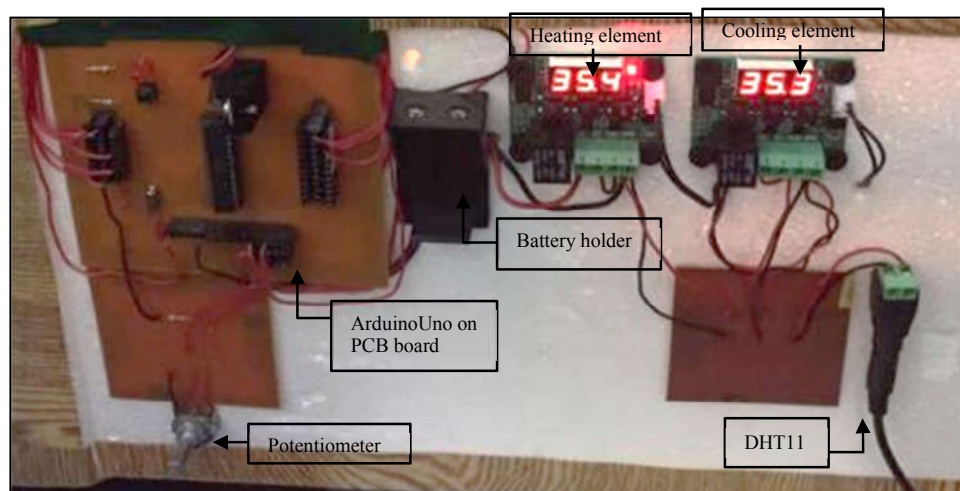

Figure 7 The circuit hardware of the incubator

The simulated circuit design of incubator was fabricated on the PCB board through etching fabrication method. Both the heating element and cooling element are combined with the humidity sensor as shown in Figure 7 above. The result of percentage humidity is shown in Figure 8 (b) below. It can be observed that, the humidity level is achieved as targeted which is 64%.

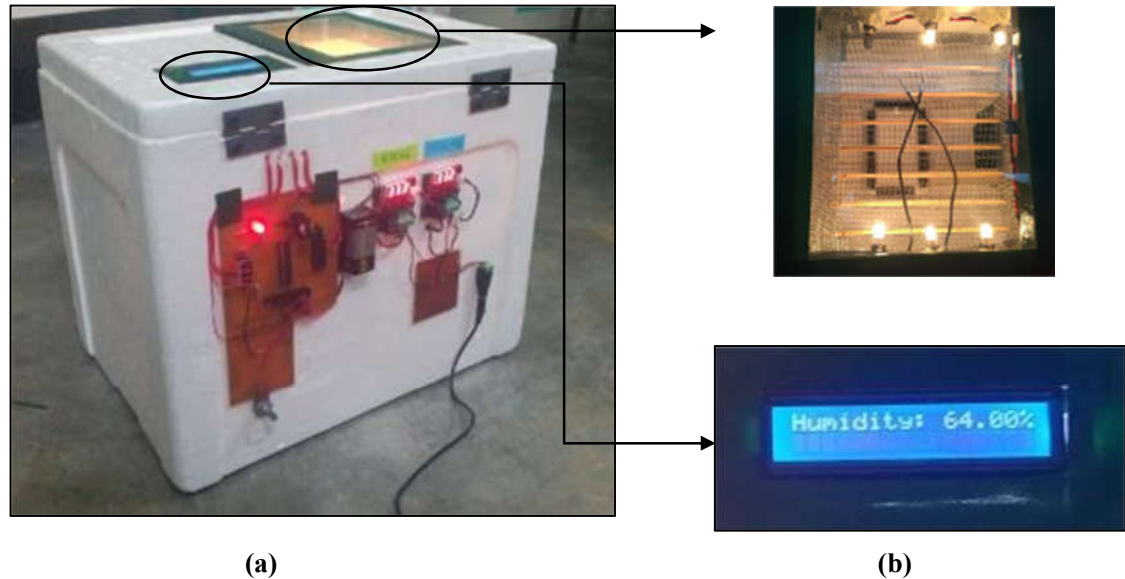
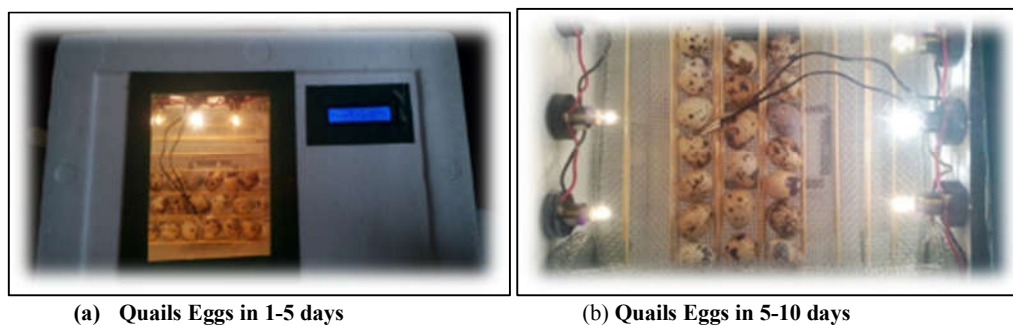

Figure 8 The prototype of the incubator (a) Condition inside incubator (b) Humidity level

The prototype of the incubator machine is made from polystyrene board as shown in Figure 8. The polystyrene is chosen because it is lightweight and easy to carry. Polystyrene is a good material which could act as heat insulator and avoid the internal heat to be released to the surrounding. The heat can be maintained and temperature level is kept constant throughout the time.

6.1 On progress results Quails Eggs within (1-16 Days)





(c) Quails Eggs in 10-16 days

Figure 9 The progress results of quail eggs

The process to hatch all the quail eggs takes 16 days. The overall progress results for hatching the quail eggs is shown in Figure 9 above. Figure 9 also shows that the quail eggs are hatched starting from the 10th day until the 16th day in this incubator machine. The eggs' turning process is performed every three days to ensure that all eggs are hatched properly. It can be observed that all the 20 eggs are successfully hatching without any failure as shown in Figure 9 (c).

7.0 CONCLUSION

The proposed incubator machine has been designed, modelled and developed to serve a dual-purpose application, unlike the imported type, which has a separate hatcher and setter. This machine can therefore be adopted by a small-scale poultry farms. The design and completion of this automatic egg incubator project could successfully provide the required conditions to hatch the eggs by automatically controlling the temperature and humidity levels.

References

- Adegbulugbe, T. A., Atere, A. O., & Fasanmi, O. G. (2013). Development of an Automatic Electric Egg Incubator. *International Journal of Scientific & Engineering Research*, 4(9), 914–918.
- Agboola, A., Olaniyi, O., & Aliyu, S. (2013). Increasing Livestock Production in Nigeria: Development of Cost-Effective Models for Bird-Egg Incubator. *Journal of Emerging Technology and Advanced Engineering*, 3(3), 707–716.
- Desha, N. H., Islam, F., Ibrahim, M. N. M., Okeyo, M., Jianlin, H., & Bhuiyan, A. K. F. H. (2015). Fertility and Hatchability of Eggs and Growth Performance of Mini- Incubator Hatched Indigenous Chicken in Rural Areas of Bangladesh. *Tropical Agricultural Research*, 26(3), 528–536.
- Ipek I Sahan U, A. A. (2015). The Effects of Different Eggshell Temperatures Between Embryonic Day 10 and 18 on Broiler Performance and Susceptibility to Ascites. *Brazilian Journal of Poultry Science Revista Brasileira*, 173, 387–394.
- Lourens, A., van den Brand, R. M. and B. K. (2005). Effect Of Eggshell Temperature During Incubation On Embryo Development, Hatchability, And Posthatch Development. *Poultry Science*, 84(6), 914–920.
- Obidiwe, A., Ihekweaba, C., & Aguodoh, P. (2014). Design and Implementation of a Microcontroller Based Egg Incubator with Digital Temperature read out . In *World Comp Proceedings*.

Ogunwande, G. A. , Akinola, E. O. and Lana, A. R. (2015). Development of a Biogas-powered

- Poultry Egg Incubator. *Ife Journal of Science*, 17(1), 219–228.
- Okpagu, P. E. & Nwosu, A. W. (2016). Development and Temperature Control of Smart Egg. *European Journal of Engineering and Technology*, 4(2), 13–21.
- Omar, M. F., Haris, H. C. M., Hidayat, M. N., Ismail, I., & Seroji, M. N. (2016). Smart Eggs Incubator System. *International Journal of Simulation: Systems, Science and Technology*, 17(41), 1–7.
- Ramli, M. B., Lim, H. P., Wahab, M. S., & Zin, M. F. M. (2015). Egg Hatching Incubator Using Conveyor Rotation System. *Procedia Manufacturing*, 2(December), 527–531.
- Romao, J. M., Moraes, T. G. V, Silva, E. E., Teixeira, R. S. C., & Cardoso, W. M. (2010). Incubation of Japanese quail eggs stored at tropical temperatures. *Livestock Research for Rural Development*, 22(1), 1–8.
- Romao, J., Moraes, T., Teixeira, R., Cardoso, W., & Buxade, C. (2008). Effect of egg storage length on hatchability and weight loss in incubation of egg and meat type japanese quails. *Brazilian Journal of Poultry Science*, 10(3), 143–147.