

Microwave Wireless Power Transfer at Multiple Frequencies

Muhamad Hazwan b Wahab
Faculty of Electrical Engineering
University Technology Mara, Malaysia
Email: mhazwan34@gmail.com

Abstract – Microwave Wireless Power Transfer (WPT) Systems one of the alternatives to replace wired power transmission in the modern life nowadays. Directive radiation antenna is used in this system to make sure power transmitted in effective way through microwaves in a long range. This paper describing about the directional radiation microstrip rectangular patch is chosen as antenna to transmit power. The WPT system is created in multiple of frequencies without degrade any performance and can reduce the size of antenna.

Keyword – Microwave Wireless Power Transfer (MWPT), Directive Radiation Antenna, Microstrip Rectangular Patch Antenna.

1) INTRODUCTION

Wireless power transfer is a great potential system in our life nowadays. The usage of the electricity can be efficient with revolution of the electromagnetic wave power transmission. Without any physical medium or wired, electrical power is transferring from one point to others. WPT can be dividing by three main part (1) Transmission. (2) Reception. (3) Rectification. This paper shown the work on WPT based on radiation technique of antenna. Power will radiated in form of wave at certain frequencies in the transmission system and propagate through the air as a medium and receive at the receiver then rectified to DC as shown in Figure 1 [1].

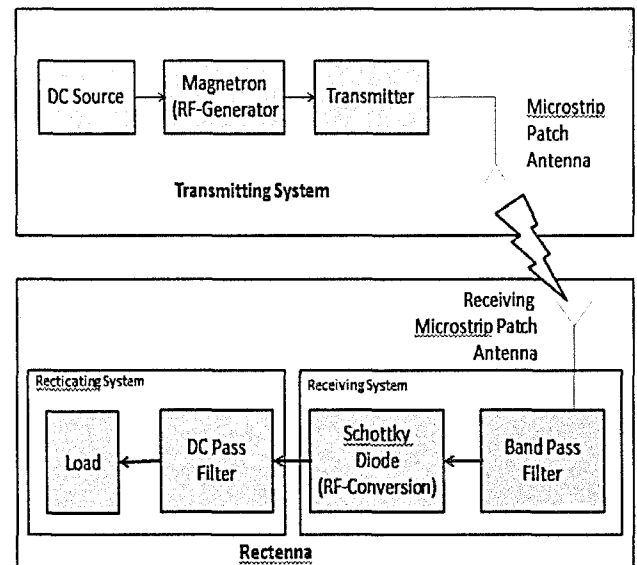

Figure 1: WPT block diagram

A. Transmission

Transmitting system is delivery RF signal in form of microwave signal as shown in Figure 1. DC source will be converting to RF signal implemented by Magnetron and carry on using transmitter to microstrip patch antenna. A microstrip patch antenna with any possible shape and created by radiating patch on one side of substrate and grounding at the other side. Signal which carry power radiated in air as medium delivery to the receiver.

B. Reception

Microwave power signal which delivered by transmitter will received at the receiving system.

Receiving system consist microstrip patch antenna in any shape and design as receiving antenna while band pass filter to remove distortion or harmonic. Receiving antenna will grab the all transmitted power from transmit antenna.

C. Rectification

Output from receiving antenna is heading to diode passed through the band pass filter. Impedance matching is required to get maximum power between filter and antenna [2].

1. Diode: It is act as conversion between microwaves to the DC in WPT system.
2. D.C Pass Filter: Output from Schottky diode is going through the DC pass filter which is the balance of microwave signal will be reflected again to the diode.

II) TRANSMITTING ANTENNA DESIGN

Microstrip patch antenna is directive radiation pattern antenna that is stacked with

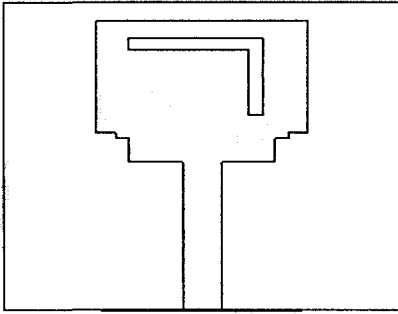

Figure 2: Single rectangular patch antenna

dielectric substrate and etched with a small size of feed line to suit with impedance matching as shown in Figure 2. Grounding will cover the rare surface of substrate.

In order to get a better result, dimension of microstrip patch antenna was calculated as follow:

$$W = \frac{c}{2f_r \sqrt{\left(\frac{\epsilon_r + 1}{2}\right)}} \quad (1)$$

W = Width

c = free space of velocity of light 3×10^8

f_r = frequency operation

ϵ_r = Dielectric constant

The calculation of the effectiveness dielectric constant (ϵ_{reff}) can be determine after knowing the value of W for antenna design.

$$\epsilon_{\text{reff}} = \frac{\epsilon_r + 1}{2} + \frac{\epsilon_r - 1}{2} \left[1 + 12 \frac{h}{W} \right]^{-2} \quad (2)$$

ϵ_r = dielectric constant

h = height of dielectric substrate

By knowing the effectiveness dielectric constant, calculation for effective length can be calculated.

$$L_{\text{eff}} = \frac{c}{2f_r \sqrt{\epsilon_{\text{reff}}}} \quad (3)$$

The physical length of patch is shorter than the effective electrical length due to fringing effect. Because of that, the total changing length is:

$$\Delta L = 0.412h \frac{(\epsilon_{\text{reff}} + 0.3) \left(\frac{W}{h} + 0.264\right)}{(\epsilon_{\text{reff}} - 0.258) \left(\frac{W}{h} + 0.8\right)} \quad (4)$$

So, the formula for actual length is

$$L = L_{\text{eff}} - 2 \Delta L \quad (5)$$

Location for feed,

$$X_f = \frac{L}{2\sqrt{\epsilon_{\text{reff}}}} \quad (6)$$

A. Inverted L-Slot

Theoretically putting L-slot at the antenna can improved the return loss at lower frequency under 10dBi.

B. Bottom Notches

Cutting notches at the bottom techniques are aimed to change the distance between the lower part of the planar with the ground plane in order to tune

the capacitive coupling and wider impedance bandwidth can be achieved.

III) SIMULATION AND RESULT

A. Dimension antenna

The microstrip rectangular patch antenna was design with a fix dimension and small size of shape without degrades any performance of antenna [3]. Dimension of substrate ($W_{sub} \times L_{sub}$) is 30mm x 26mm with 1.6mm of thickness and 4.7 of relative dielectric constant (ϵ_r) designed on FR4 lossy. Dimension of rectangular patch ($W \times L$) is 16mm x 12mm is connected by feed line with 3mm width line that printed on the substrate. The other side of substrate is covered by the grounding. This antenna will be achieved by adding inverted L slot with 1mm gap spacing. In order to get a better return loss, optimize antenna with two notches is created as shown in Figure 2.

B. Impedance characteristics of antenna

The simulation results obtained from CST software with desired frequency.

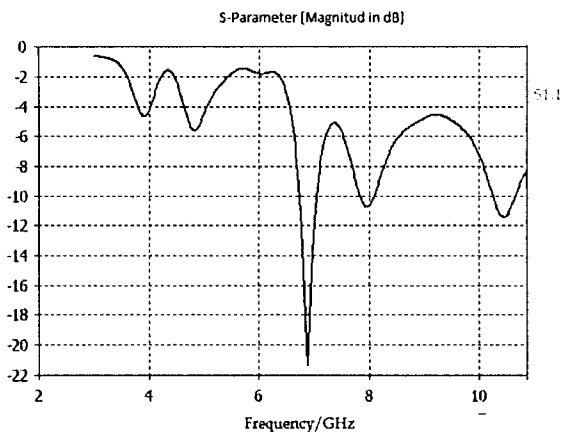

Figure 3: Simulation of return loss (S11)

Result S_{11} vs frequency is shown in Figure 3. It has 50Ω input impedance. The return loss of the antenna at frequency 6.8GHz is respect at almost 21 dB. Mean this microstrip antenna really working at that frequency.

C. Farfield radiation pattern characteristic

The antenna is created to operate at 6.8 GHz. The theoretical and simulated data are quite matching that covered under -10 dB [4]. The 3D radiation pattern for antenna is shown in Figure 4 and Figure 5 in polar view which is operating at 6.8GHz. The gain of antenna is 6.1dBi.

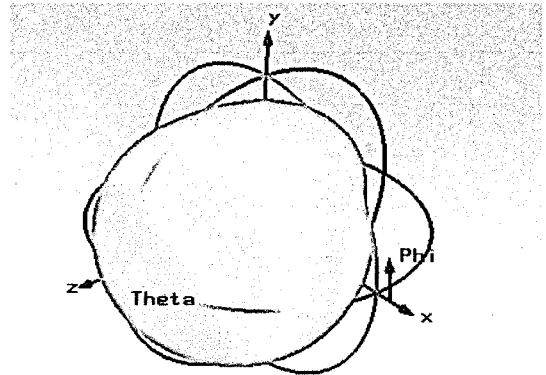

Figure 4: 3D radiation pattern microstrip patch antenna

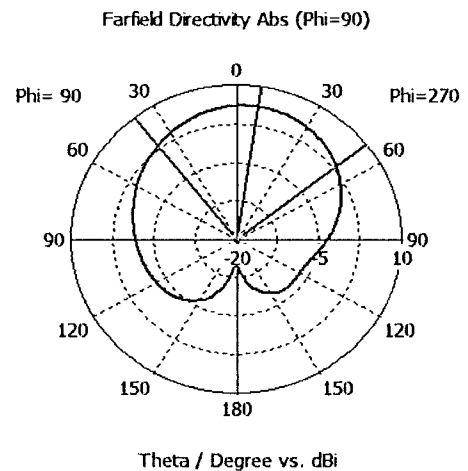

Figure 5: Radiation pattern In polar view

D. Antenna performance with uniform flat lens.

A WPT system was designed by using two same kind of microstrip antenna that put with uniform inverted facing patch as shown in Figure 6 by 10mm distance.

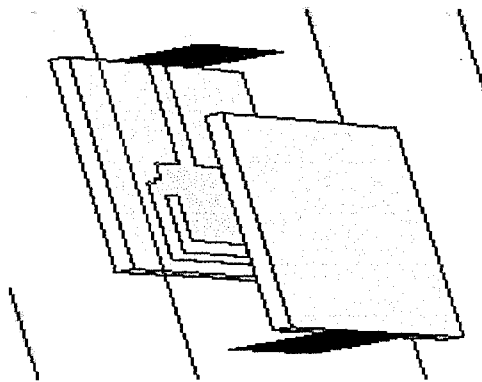

Figure 6: Microstrip with uniform flat lens.

The return loss of WPT is shown in Figure 7 which is two frequency that operate under -10 dB and 2.7 dBi gain.

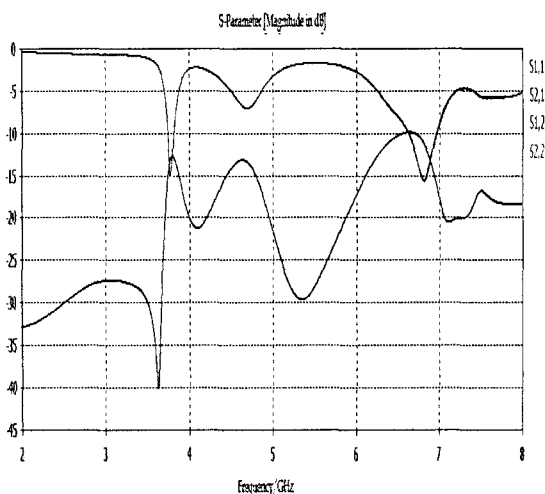

Figure 7: Simulation of return loss with uniform flat lens

IV) CONCLUSION

A microstrip patch antenna with inverted L slot and 2 notch etched by feed line and FR4 lossy as substrate has been proposed in WPT system on this paper. Two similarity of antenna has been design in this system separately by a certain distance to transfer power.

Based on simulation, antenna is operating on two frequency 3.78 GHz and 6.8 GHz. Hence, the proposed antenna is really suitable for usage of wireless power transfer in multiple frequencies.

REFERENCES

- [1] Vikaram Singh, Asawari Kukde, Chirag Warty, Sushama Wagh, "Wireless Power Transfer Using Metamaterial Bonded Microstrip Antenna for Smart Grid WSN", Fourth International Conference on Advances in Computing and Communications, 2014
- [2] Vikaram Singh, Asawari Kukde, Chirag Warty, Sushama Wagh, "Wireless Power Transfer Using Microstrip Antenna Assigned with Graded Index Lenses for WSN", Advances in Computing, Communications and informatics (ICACC1), 2014 International Conference on
- [3] Inam Abbasi, Syed Atif Adnan, Muhammad Amin, Farrukh Kamran, "Wireless Power Transfer Using Microwaves at 2.45 GHz ISM Band", Applied Sciences & Technology, Jan (2009), International Bhurban Conference on
- [4] Sharanbasappa B Belangi, Prosenjit Das, Sudhabindu Rai, "Suspended Planar Patch Antenna for Wireless Energy Transfer at 2.45GHz".
- [5] Abdul Mueed, Dr M. Noman Jafri, S.Irteza Butt, "Integrated Design of Rectenna Using Microstrip Patch for Wireless Power Transfer at 4.3 GHz", Applied Sciences & Technology, Jan (2009), International Bhurban Conference on
- [6] Juseop Lee, Yong-Seok Lim, Woo-Jin Yang, and Seung-Ok Lim, "Wireless Power Transfer System Adaptive to Change in Coil Separation", IEEE Transactions on Antennas and Propagation Vol 62, February, 2014
- [7] Dr.S.S.Verma, "Power over Fiber", Science Tech Entrepreneur, October, 2007
- [8] Hyo-Soon Kang, Myung-Jae Lee, and Woo-Young Choi, "Radio-Over-Fiber Systems for WLAN Based on CMOS-Compatible Si Avalanche Photodetectors ", Microwave Symposium Digest, 2008 IEEE MTT-S International.
- [9] Anthony Ng'oma, "Radio-over-Fibre Technology for Broadband Wireless Communication Systems", Jun,(2005).
- [10] Expert Working Group EWG-4, "Optical Fibre Technologies and Radio over Fibre Strategic Research for Future Networks", eMobility Technology Platform, (2010)