



**UNIVERSITI TEKNOLOGI MARA
FACULTY OF INFORMATION MANAGEMENT**

**INDUSTRIAL TRAINING REPORT:
ERA BIO ADVANCE (M) SDN BHD**

**NO2-2, JALAN PJS 8/18, SUNWAY MENTARI, 46150, PETALING JAYA,
SELANGOR, MALAYSIA**

SPECIAL PROJECT: MYSUDIP WEBSITE AND MOBILE APPLICATION

BY:

**MUHAMMAD FAEIZWAN BIN JAAFAR
2014706853**

**IM245 - BACHELOR OF SCIENCE (HONS.)
INFORMATION SYSTEM MANAGEMENT
FACULTY OF INFORMATION MANAGEMENT
UNIVERSITI TEKNOLOGI MARA KELANTAN**

01 FEBRUARI 2017 – 30 JUNE 2017

INDUSTRIAL TRAINING REPORT
PROGRAMMER DEPARTMENT ON ERA BIO ADVANCE (M) SDN BHD

SPECIAL PROJECT: MYSUDIP WEBSITE AND MOBILE APPLICATION

BY:

MUHAMMAD FAEIZWAN BIN JAAFAR

FACULTY SUPERVISOR

SIR MOHD IDZWAN BIN MOHD SALLEH

**REPORT SUBMITTED IN FULFILLMENT OF THE
REQUIREMENT FOR THE INDUSTRIAL TRAINING
FACULTY OF INFORMATION MANAGEMENT
UNIVERSITI TEKNOLOGI MARA KELANTAN
01 FEBRUARI 2017 – 30 JUNE 2017**

DECLARATION

I hereby declare that this is my original work. I have not copied from any other student's work or from other sources. I am also declare that no part of this report has been published or submitted for publication except where due to reference or acknowledgement is made explicitly in text, nor has any part been written for me by another person. I confirm that I have read and understood the UiTM regulations with regards to plagiarism and will be penalized by the university if found guilty.

Signed by

Muhammad Faeizwan Bin Jaafar
2014399263

Date of submission:
13 July 2017

ABSTRACT

The industrial report is based on the industrial training period from 01 February 2017 to 23 June 2017 at Programmer Department under Era Bio Advance (M) Sdn Bhd. This report entails the experience of mine, the background of organization where I had my practical training and, the industrial training activities I have done throughout the five months period in software development industries. Industrial training is compulsory to all Semester 7 students of Faculty of Information Management, UiTM Machang as it is the partial fulfilment of the requirement in order to be awarded degree in Information Management study. The report of this practical training consist four chapters which are introduction, organization information, Industrial training activities and Conclusions. The main inputs in this report are chapter 3 and chapter 4. Writer will explain in depth activity done within five months here and special project that writer has done. Chapter 4 will cover about knowledge gained, personal opinion, lesson learnt and limitation and suggestion from writer perspective.

Keywords: *Website Development, Industrial training, Programmer Development, Mobile Application Development.*

ACKNOWLEDGEMENT

In completing this industrial training, I had received a lot of support and guidelines from the respected person. It is one of the reasons why they should have my appreciation. First of all, I would like to thank to the Almighty, Allah S.W.T because I could finished this industrial training report on the time. With the gust and guide that He gives to us, I can finish up this industrial training report completely without any obstruction. With the strength that He has given to us, it has inspired us in many ways to find necessary information to complete this industrial training report.

Secondly, I would like express my appreciation to the management of Faculty of Information Management UiTM Machang for allowing me to undergo my industrial training on the time. Other than that, a special appreciation should be given to the Era Bio Advance (M) Sdn Bhd management and staffs for the opportunity to undergo my industrial training at this company, especially Mrs Rosnani AB. Rahman, the supervisor during the internship program for all the knowledge sharing about the organization and the introduction of the organization business function. A whole lot of new experienced had been exposed alongside the industrial training period.

I also would like to express my gratitude to both my beloved industrial supervisor from faculty and from the organization which is Mohd Idzwan Bin Mohd Salleh, Lecturer of UiTM Machang for the guidance in completing this industrial training. Without the consultation and helped from him, I find it difficult to complete this industrial training report. Apart from that, a big thanks to my parents that have been supporting me in finishing this industrial report. Both of them had always given moral support and encourage me alongside this industrial training period.

Thank you so much to all, Alhamdulillah.

Contents

Introduction	7
OBJECTIVES OF INDUSTRIAL TRAINING.....	7
PURPOSE INDUSTRIAL TRAINING.....	8
1.0 Organization background.....	10
1.1.1 Organization Logo	13
1.1.2 Vision	14
1.1.3 Mission.....	14
1.1.4 Objective	15
1.2 Organization Structure	15
2.1 Department Structure.....	17
2.2 Department Function.....	18
3.1 Training Activities.....	20
3.1.1 Content Management System (CMS).....	20
3.1.2 Mobile Application Development.....	26
3.1.3 Managing Facebook Pages.....	30
3.1.4 Events.....	31
3.1.5 Video.....	32
3.1.6 Designing Flyers and posters	34
3.1.7 Meeting and presentation.....	35
3.2 Special Project	37
3.2.1 Website Development.....	37
3.2.2 Mobile Application Development	39
3.2.1 Problem Statement.....	40
3.2.2 Objective	40
3.2.3 Entity Relational Diagram	41
4.1 Application of Knowledge, Skills and Experience.....	43
4.2 Personal Thoughts and Opinion.....	44
4.3 Lesson Learnt.....	45
4.3.1. Time Management.....	45
4.3.3. Be responsible.....	45
4.3.4. Improve self-confident.....	46
4.3.5. Leadership	46
4.4 Limitations and Recommendations.....	47
4.4.1 Limitations.....	47
4.4.2 Recommendations.....	47

5.0 References.....48
Appendices48



Table Of Figures

Figure 1 Era Bio Advance (M) Sdn Bhd	10
Figure 3 Myapps99 Logo	13
Figure 4 Era Bio Advance Logo	13
Figure 5 : Latest Logo of Era Bio Advance.....	14
Figure 6 Organization Structure of Era Bio Advance.....	15
Figure 7 Pewittv Logo	22
Figure 8 Pewittv Homepage	22
Figure 9 Pewittv Course Page	23
Figure 10 Myapps99.biz Homepage1	24
Figure 11 Myapps99.biz Homepage2	24
Figure 12 Sifopets Homepage	25
Figure 13 Sifopets Shop page	25
Figure 14 Era Bio Advance Application.....	27
Figure 15 Era Bio Advance Application menu bar.....	27
Figure 16 Nasihat Kewangan Application splash screen.....	28
Figure 17 Nasihat Kewangan Application Article page.....	29
Figure 18 Pewittv Facebook Page	30
Figure 19 Myapps99 Facebook Page	31
Figure 20 Demi Seekor Kucing Event Poster.....	32
Figure 21 Era Bio Advance Raya Video.....	33
Figure 22 Poo Pee Spray Advertisement Video.....	33
Figure 23 Fur Grow Up Contest Flyers	34
Figure 24 Myapps99 Flyers	35
Figure 25 Meeting at DPIMKL.....	36
Figure 26 Meeting at MDEC	36
Figure 27 Mysudip Logo	37
Figure 28 mysudip.com/mysudip home page.....	38
Figure 29 mysudip.com/mysudip Login Page	38
Figure 30 Dmysudip application Front page.....	39
Figure 31 Dmysudip application article page	40
Figure 32 Mysudip Entity Relational Diagram.....	41

Introduction

The Industrial Training subject of code IMC690 is the subject that should be required by all final year students from Faculty of Information Management whether Library & Information Management, Resource Centre Management, Information System Management and Records Management to qualify them obtained a degree. This subject provides pre-professional work experience with specific assignments and responsibilities. Students are required to undergo industrial training as the one of the conditions to completion degree in their fields and as the degree holder. Students need to finish and complete the industrial training for five months with projects or event was carried out in certain organizations that were determined.

This paper involve 480-hour equivalent work placement, paid or unpaid, located in an approval industrial site, working under the supervision of an experienced Information Professional. During the industrial training, the student is expected to contribute to the activities of the workplace and to meet the same demands of work production and responsibility expected by the organization of its regular employees. An Industrial Training programmed is relevant to a student's personal career interests and improve their marketability after graduation. Students have opportunity to apply the knowledge that learn before this in the class and it will make students more think more rational foresight to produce graduates who have the skills and expertise in line with the current needs of the organization.

OBJECTIVES OF INDUSTRIAL TRAINING

During practical training students have to write in the daily log book. All information set forth as a guide to produce a log book. Students can write any work done, work through the explanation of the observed and heard. Among the objectives of the report are:

- a. Documenting the activities or functions of the industrial training;
- b. Meet some of the requirements for courses taken prior to the award of certificates, diplomas and degrees;
- c. To serve as a testament to the training that has been followed and can also be used during future job interviews;
- d. Can be used as a reference in the future; and
- e. To increase the level of confidence and communication skills with the general public.

- f. To provide pre-professional work experience with specific assignments and responsibilities.
- g. To encourage or stimulates a personal career interest, serving as a bridge between university and the world of work.
- h. To encourage students to apply the skills and knowledge gained at the university to benefit the organizations.
- i. To adapt management and technical skills in a library and information environment.

PURPOSE INDUSTRIAL TRAINING

Industrial training undergone by the final year students' faculty of information management is required to have a report as evidence of the results of the learning process in the organization. The industrial training report is a report that must be completed for students who have been training for five months in the industry specific organizations. This report clearly explains the practical work and theory that has been learned and implemented during industrial training.

Besides that, this semester for academic writing has been repealed and replaced by a special project to be undertaken by students in their respective organizations. In this way, students can train themselves to control project or event in the organization before dealing with actual reality as an employee in the future. The industrial training students must make a full report on what they had done during the period of industrial training.

The main purposes of industrial training report are:

- a) Give the impression to reader about the activities carried out within the framework of the students and to the role of the department or the firm.
- b) As an initial overview and reference for students who will undergo industrial training.
- c) Describing the work done by the student daily report book.
- d) As a book to gather all the information and data obtained during industrial training.

Chapter 1: Introduction

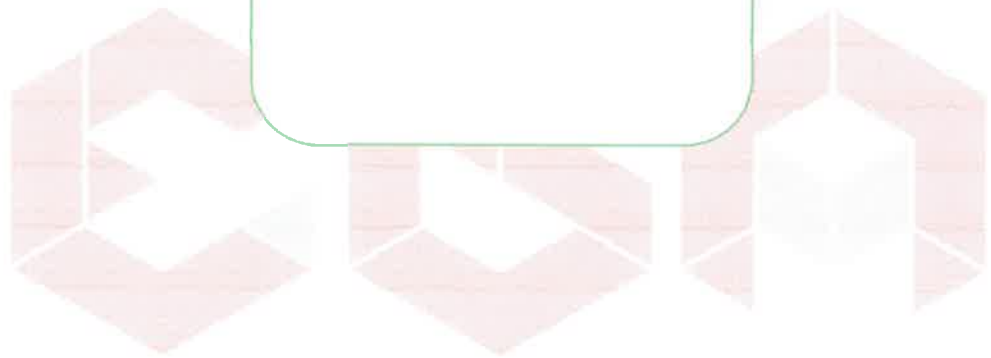

CHAPTER 1: INTRODUCTION

1.0 Organization background

Era Bio Advance (EBA) Sdn Bhd is a company that run a chain of health products that are mainly used in hospitals and end user. This company is based at Sunway Mentari, Petaling Jaya, Selangor. Basically this company started to operate on the midyear of 2015. This company is operated from 9am – 6pm from Monday to Friday. The Example of products is Execzema by Newgenn, Newgenn Pets Care, Fur Grow Up and many more. All products produce by EBA is using bio technology to replace dangerous chemicals in enhancing the quality of the product. Therefore, the product is safe and suitable to be used by people and animal.



Figure 1 Era Bio Advance (M) Sdn Bhd

Execzema by Newgenn

Execzema by Newgenn is a special made products for end user that experience eczema disease. Eczema disease is a medical condition in which patches of skin become rough and inflamed with blisters which cause itching and bleeding. Eczema

patients have to be treating well as they cannot be exposed by chemical products and high pH of substance. Therefore, EBA produce Eczema by Newgenn to help people that have eczema disease which ensure that the product is free from dangerous chemicals and alcohol.

Newgenn Pets Care

Newgenn Pets Care is a product that specially made for pets such as cat, dog, rabbit, and many more. As EBA main goal is producing a product that free from dangerous chemicals and alcohol, Newgenn Pets Care products is suitable to be used in their pets.

Fur Grow Up

Fur Grow Up is a product that will make the cat healthy and fluffy. This product is made by natural base products with using bio technology process to extract natural ingredients such as fish extract, wheat extract, and soya bean extract. With this element, people are more confident to try the product for their cat. There are 8 products of Fur Grow Up, which is Poo Pee Spray, Pets Mist, Drink, Vitadrink, Serum, Juice, Catz Builder, and Anti-lice. The first product which is Poo Pee Spray using Advance Odour Technology which is the function is to losing tang. Next is the Pets Mist. Pets Mist function is like a body perfume for your pets and it can make your cat fur become pretty. Other than that, the product is Drink. The function of drink is to strengthen your cat fur and increase appetite of your pets. Next, the product is vitadrink. Vitadrink function is to prevent cough, flu and fever, and to increase the health of your pets. Furthermore, the product that Fur Grow Up has is Serum. The function of Serum is to strengthen and improve the fur structure of your pets. The best thing of this product is it is alcohol free product. The next one is Juice. The function of this product is to improving the body immunisation, stamina and muscle. Other than that, this product

also can increase the appetite and increase pet's fur from inside. The next product is Catz Builder. This product function is to fatten your pets and it has 80% of high protein and contains amino acid from fish. The last product is anti-lice. The anti-lice are a serum that is free from alcohol. The function is to kill lice and soften the fur of your pets.



Figure 2 Fur Grow Up Logo

Myapps99

Myapps99 is a platform that was created under EBA where it is the platform to create a mobile application. The Myapps99 could create the mobile application and by using this Myapps99, time could be saved and the apps could be publishing faster. Myapps99 could make a big impact on apps development advancement.



Figure 3 Myapps99 Logo

EBA and online marketing

EBA has been doing business online since the beginning. This is because online business is easier to handle and require less capital. Nowadays, online businesses more easily handled and have a big impact on consumers, mostly advanced by using online applications such as Facebook.

1.1.1 Organization Logo



Figure 4 Era Bio Advance Logo

This is Era Bio Advance old logo. Basically this is the old logo of the company. This logo has been used by this company until April 2017. Since May 2017 the company has changed their logo to a new one.



Figure 5 : Latest Logo of Era Bio Advance

In figure 2 shows the recent logo of Era Bio Advance. This logo has been used from May 2017 until now.

1.1.2 Vision

Branding, believed in health care products using bio technology that enhance the quality of product and satisfaction of end user.

1.1.3 Mission

To develop and introduce health care products that is safe and effective by bio technology method to be use by people and animal.

1.1.4 Objective

Establish a brand that can be seen as trigger chemical free and safe products of toxic substances that are harmful to humans and animals.

1.2 Organization Structure

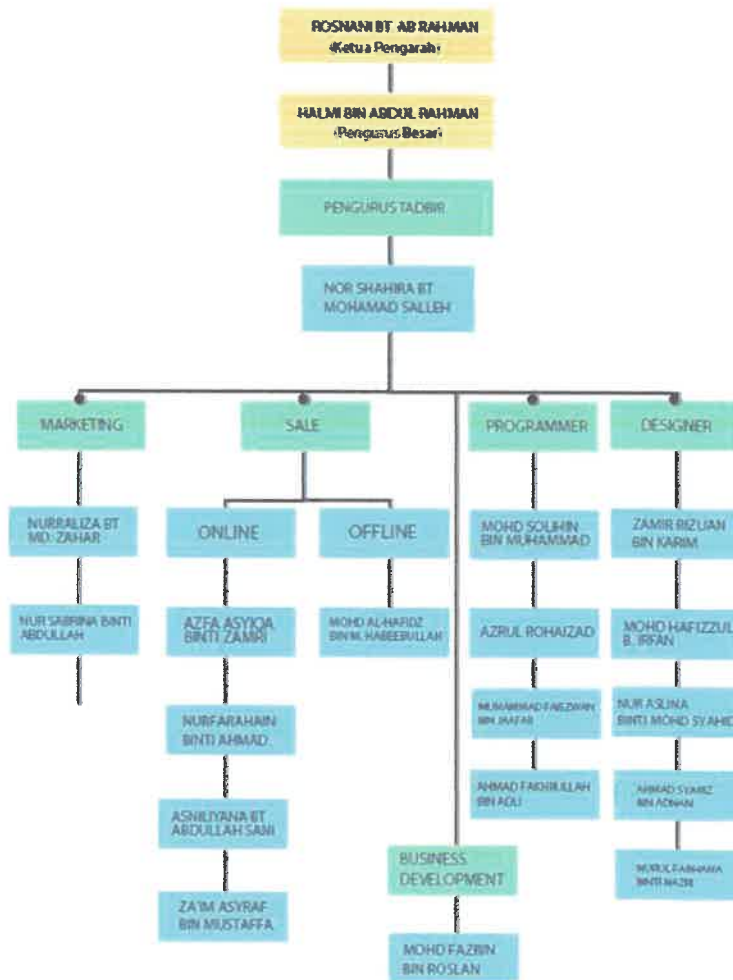
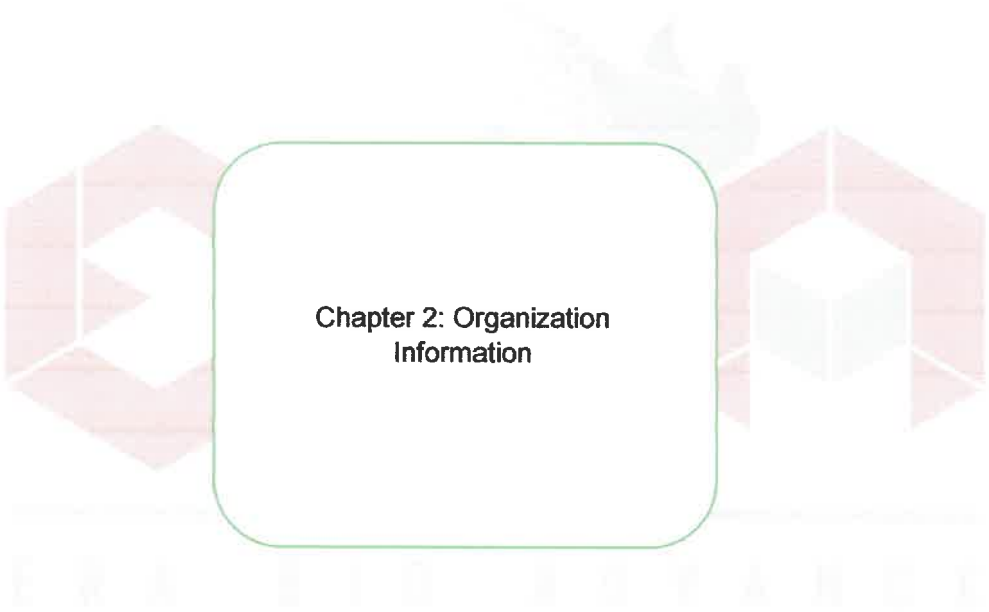

Figure 6 Organization Structure of Era Bio Advance



**Chapter 2: Organization
Information**

This chapter covers about the information on the departmental structure of the department that I work for.

2.1 Department Structure

In this company, there are 6 departments that will organize the daily operation of this company. The first one will be administration department. This department consist of one person only where this department is one of the most important roles in this company.

The second one is the marketing department. Marketing department is consisting of 2 persons. Marketing department can be call as the mastermind of this company where they will determine and create any program for this company.

The third one is sales department. In this company, the sales department is being divided in two group which is offline and online. The offline sales team will make an offline sale where they will make a direct approach to customer and meet them face to face to make sales or to close up the sales. Meanwhile, the online sales team will make sales through online where the Social Medias take places such as Facebook.

The next department will be the business development. The role of the business development is to expand the branding and increase the product demand with making a research throughout the entire Malaysia and outside of Malaysia such as Indonesia and Thailand.

Furthermore, the department that Era Bio Advance is the designer department. This designer department consist of 5 persons. The role of this department is to help marketing, sales and other department to create advertisement such as video, poster, logo and other designing job.

The last department will be the programmer department. This department consist of 4 persons. Basically, this is the department that I work for and being placed

for these 5 months. The role is to develop and maintain the website and mobile application.

2.2 Department Function

For the past five months in Era Bio Advance, I have been put on the programmer department. So I have work or learn on how to be a programmer for these past few months. The programmer in this company consist only 4 persons. Basically, as a programmer in this company, we are assigning to handle the Myapps99 project. This project is an Information Technology project where it will lead us to make website, system and mobile application. Myapps99 is the platform to create mobile application on your own where the mobile application could be customized.

The function of this department is to handle the website and mobile application. Basically the job that will be assigned to us is to develop and maintain the website and mobile application. The website that being handle by us not just the company website, it also contains website from our customer and the company others project. Same goes to the mobile application, we will develop it according to our customers request and our general manager request. Other than that, the function of this department is to publish the mobile application that already being developed into Google Playstore and Apple Store. We will need to monitor that our request to publish the mobile application and we need to make sure that it is not rejected by Google Playstore and Apple Store.

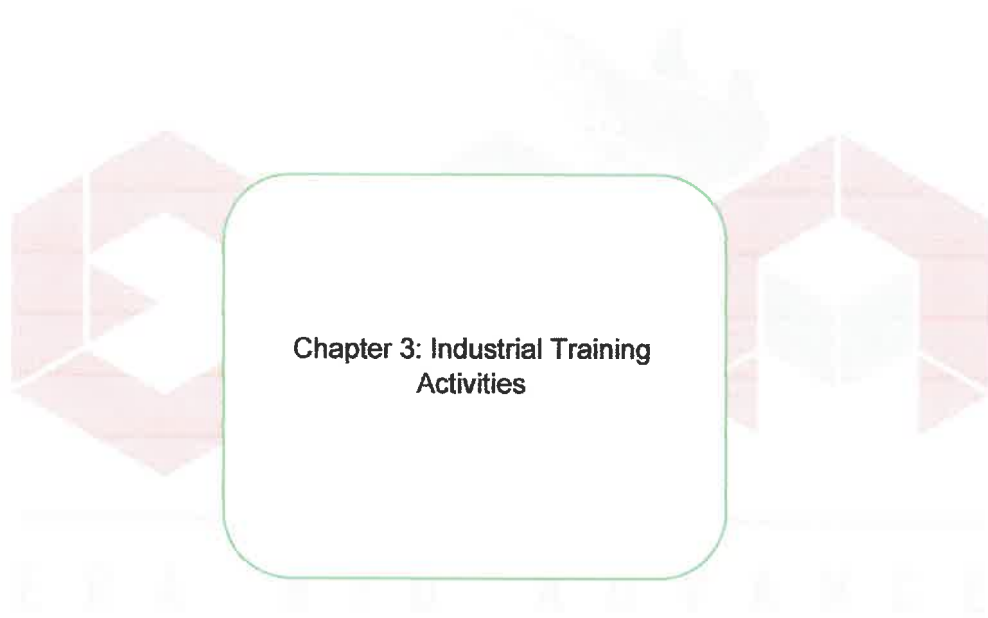

**Chapter 3: Industrial Training
Activities**

3.1 Training Activities

The Industrial Training subject IMC690 is compulsory subject for semester 7 or final year student of Bachelor of Science (Hons) Information System Management. This course provides pre-professional work experience with specific assignments and responsibilities.

During the industrial training, the student is expected to contribute to the activities of the workplace and to meet the same demands of work production and responsibility expected by the organization of its regular employees. An Industrial Training programmed is relevant to a student's personal career interests and improve their marketability after graduation (Faculty of Information Management UiTM, 2017).

The training will be clustered and reported using activity-based. Trainee has been assigned into Programmer Department, Era Bio Advance Sdn. Bhd. to develop and maintain any website that is requested by customer or company.

3.1.1 Content Management System (CMS)

A content management system (CMS) is a computer application that supports the creation and modification of digital content. It is often used to support multiple users working in a collaborative environment. CMS features vary widely. Most CMSs include Web-based publishing, format management, history editing and version control, indexing, search, and retrieval. By their nature, content management systems support the separation of content and presentation. A Web content management system (WCM or WCMS) is a CMS designed to support the management of the content of Web pages.

There are many types of CMS. At Era Bio Advance Sdn Bhd the trainee has been asked by employer to use wordpress. Trainee is being introduced to wordpress since the first week of the internship program started. At first, the employer will give

time to the trainee to explore the wordpress. After given some times on exploring the wordpress, employer will make discussion and give special project task for the trainee. The first task given to the trainee that using wordpress is Mysudip. The trainee were assigned to develop and designing Mysudip website. On the progress of the Mysudip website designing, there are a lot of discussion has been made with the employer such as the logo of Mysudip and the progress of the project development. After the website has been developed, the trainee need to maintain the website by making an update on the features of the website. The trainee is required to make an update, maintain and make an observation on the Mysudip website. Lastly, when the website development is fully finished, the trainee just need to make a post and update the content of the website.

Mysudip is a website where it is a platform for food and beverages to be promoted or to be found. The main reason of this website is to help and food and beverages business owner to market their restaurant, stall and catering services to be promoted on this website. So the food hunter that likes to search for food can visit this website to look for food around them. This website also can help their user to find any place for their breakfast, lunch or dinner around them and the best thing is this website is connected to the Google map. The trainee has linked this website and Google map so that it is easy for the user to find the places.

The other project that involving the Content Management System (CMS) is Pewittv. The trainee has been given a new project which is to handle the Pewittv project. The trainee is required to develop the Pewittv website. Pewittv is a website that provides an online tutorial and tuition for any kind of subject, but the main subject is business. This website function is to enable their user to study any subject that they want anywhere and anytime as long as there is internet connection. During the progress of this project, there are many discussion has been made between the trainee and the programmer team and the employer. After the development of this website has finished, the trainee is required to update this website features. Other than that, the

trainee is required to maintain and update the content of this website so that this website looking very active.



Figure 7 Pewittv Logo

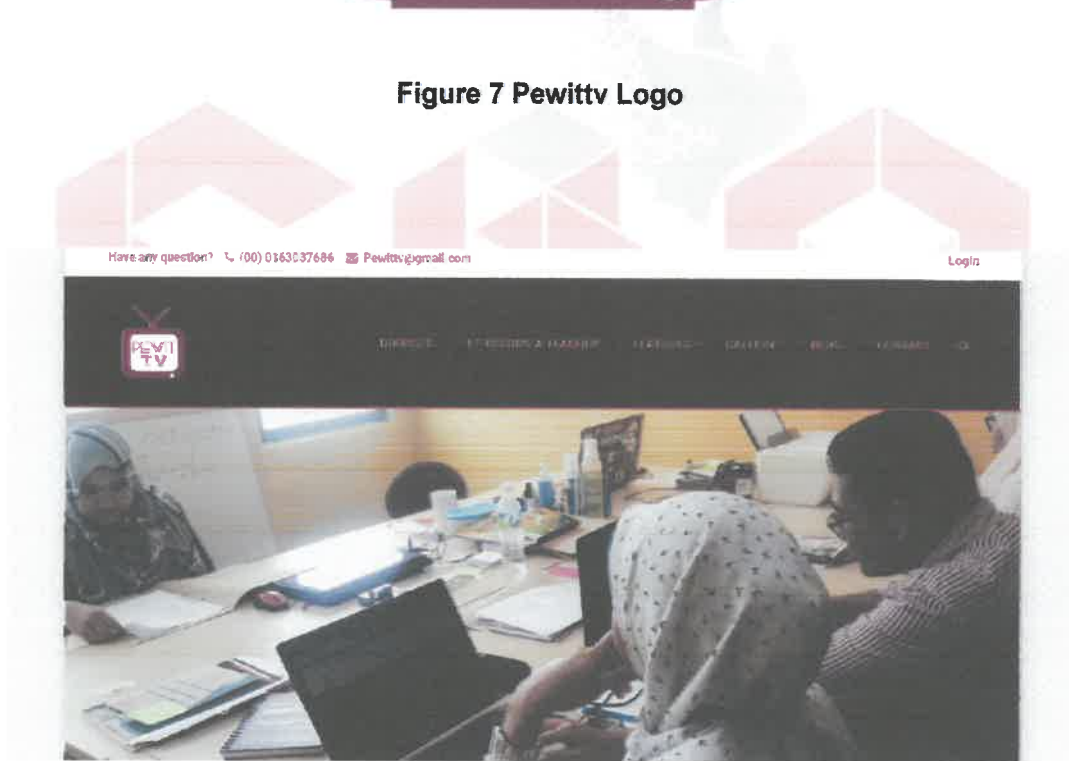

Figure 8 Pewittv Homepage



Figure 9 Pewittv Course Page

Other than that, the trainee has been given a task to develop myapps99.biz website. This website is basically a website about the information about the myapps99 project that currently being run in Era Bio Advance (M) Sdn. Bhd. The trainee will follow the development website step in finishing the development of myapps99.biz website. After the website has been created, the trainee is required to add new content to the website. Other than that, the trainee will be given a task to add new plugin to myapps99.biz website. Then, a chat system has been requested by the employer to be added to myapps99.biz website. Furthermore, the trainee is required to add user profile management plugin in myapps99.biz website. Other than that, the trainee has been given a task to create an agent flow system in myapps99.biz website.



Figure 10 Myapps99.biz Homepage1



Figure 11 Myapps99.biz Homepage2

Furthermore, the task that has been given by the employer is to create myapps99pos.com. This website is an informative website about the Point Of Sale (POS) system that is provided by Era Bio Advance (M) Sdn. Bhd.

The next project is the project of developing customer website. The website is known as sifoopets.com. The trainee has been given a task to setup and develop the sifoopets.com website. Then, the trainee is being asked to add some new features in

sifoopets.com website. After that, the trainee is required to add product into the sifoopets.com website. Other than that, the client is requesting the trainee to add new section in sifoopets.com website. After that, the trainee has set an appointment the the sifoopets staff to meeting about the sifoopets project. Lastly, the trainee has to maintain the sifoopets.com website.

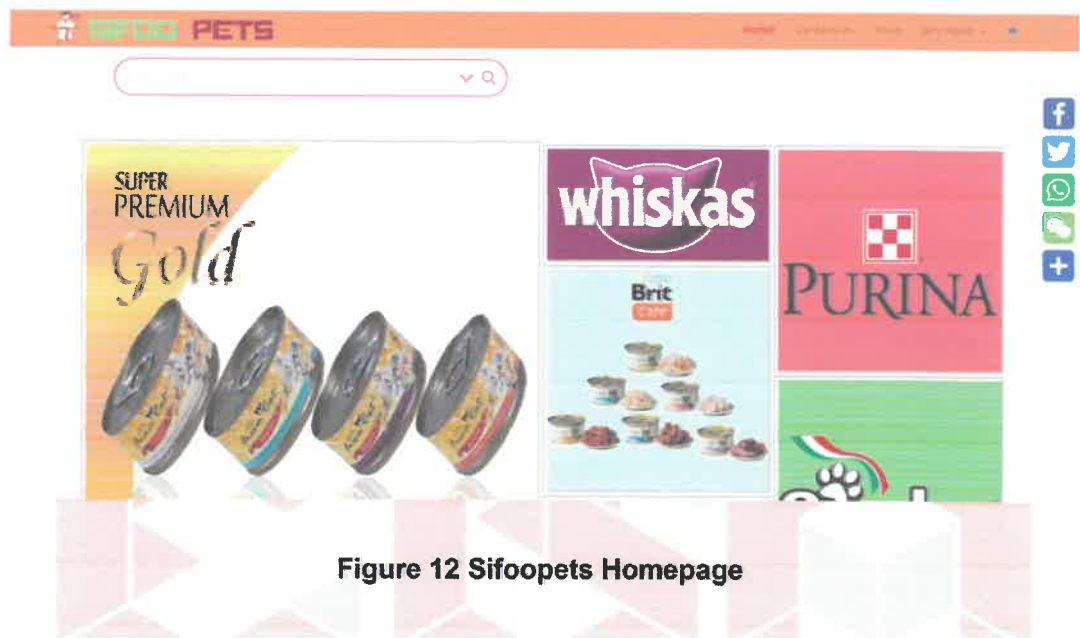

Figure 12 Sifoopets Homepage

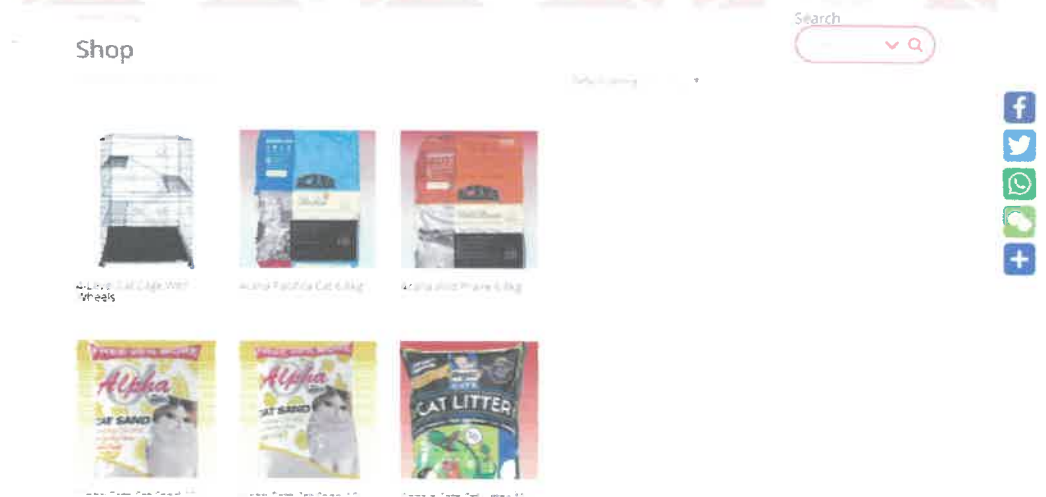

Figure 13 Sifoopets Shop page

Lastly, the trainee need to do maintenance on the entire website that has been registered under the name of Era Bio Advance (M) Sdn. Bhd. The trainee need to

always check the website in terms of if there is any problems occur in the website such as bug and others.

3.1.2 Mobile Application Development.

In Era Bio Advance (M) Sdn. Bhd. as a programmer, the trainee has been given a task to develop a mobile application. Era Bio Advance (M) Sdn. Bhd. has prepared a platform for all programmers in the company to create a mobile application where it has been given a name of Myapps99. Myapps99 is the platform to create a mobile application where it is very effective. There is some mobile application that has been developed by the trainee using this Myapps99 platform. The trainee has been given the time to explore the Myapps99.

The first task that the trainee got from the employer is to develop Dmysudip mobile application. The first step in developing the Dmysudip application is the trainee is required to design the interfaces of the application. When the mobile application development has been done the trainee is required to make an update for the application. After the development has been completed, trainee is required to publish the Dmysudip mobile application to Google Playstore. But at first, this mobile application has been rejected by Google Playstore due to some reason. So, the name of mysudip has been changed to Dmysudip. It took around 24hours from Google before the approval has been made for Dmysudip. After Dmysudip mobile application has been officially publish to the Google Playstore, the trainee need to test the application. Lastly, when everything is already completed, the trainee needs to monitor and maintain the mobile application.

The next task that has been given by employer to the trainee is to create Era Bio Advance referral mobile application. The Era Bio Advance mobile application is the referral application where it is to give information about the company and details about what is Era Bio Advance (M) Sdn. Bhd. has been doing. As usual the first step is to

design the interfaces layout for the application. Then, there are some new section that has been added to the Era Bio Advance mobile application as requested by the employer. After the Era Bio Advance has been developed completely, the trainee is required to publish the application to Google Playstore.

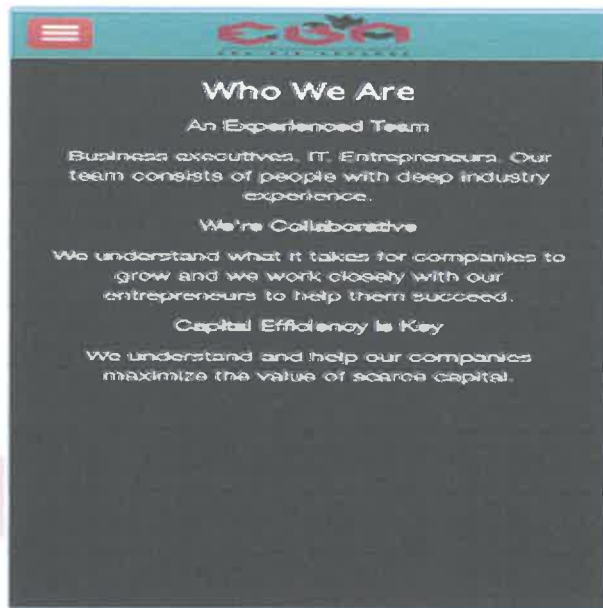

Figure 14 Era Bio Advance Application



Figure 15 Era Bio Advance Application menu bar

The next task on Mobile Application is to create Nasihat Keuangan mobile application. After the development of the application has been completed, the trainee is required to manage Nasihat Keuangan mobile application. After the Nasihat Keuangan mobile application has been completed, the trainee is required to maintain the application.



Figure 16 Nasihat Keuangan Application splash screen



Figure 17 Nasihat Kewangan Application Article page

Other than that, the employer has given a task to the trainee to develop and create sifooPets mobile application based on the request by the customer. Other than that, the trainee has been given the task to add the entire product that sifooPets has in the store to be added to the mobile application. Other than that, the trainee needs to add some new section in sifooPets mobile application. After that, there is some maintenance need to be done for the sifooPets mobile application. During the progress of the development of this application, the customer has requested to the company to create a new design for the application. So the employee has assigned the trainee for the task to create new design for sifooPets mobile application.

Lastly, after the development of the project has been finished, the trainee is has been given a task maintain all the mobile application that has been registered under Era Bio Advance (M) Sdn. Bhd. Other than that, the trainee will do any task or update depends on the request of the employer and customer.

3.1.3 Managing Facebook Pages

Since the first week until the last day of the trainee internship, the trainee has been given a task to manage the Myapps99. There are several Facebook pages that the trainee needs to manage. The Facebook pages that the trainee need to manage is Myapps99 and Pewittv. The trainee is required to update the Facebook pages and need to insert some content in the Facebook pages. Other than that, the trainee also responsibility is to response to anything that is going on with the Facebook pages.

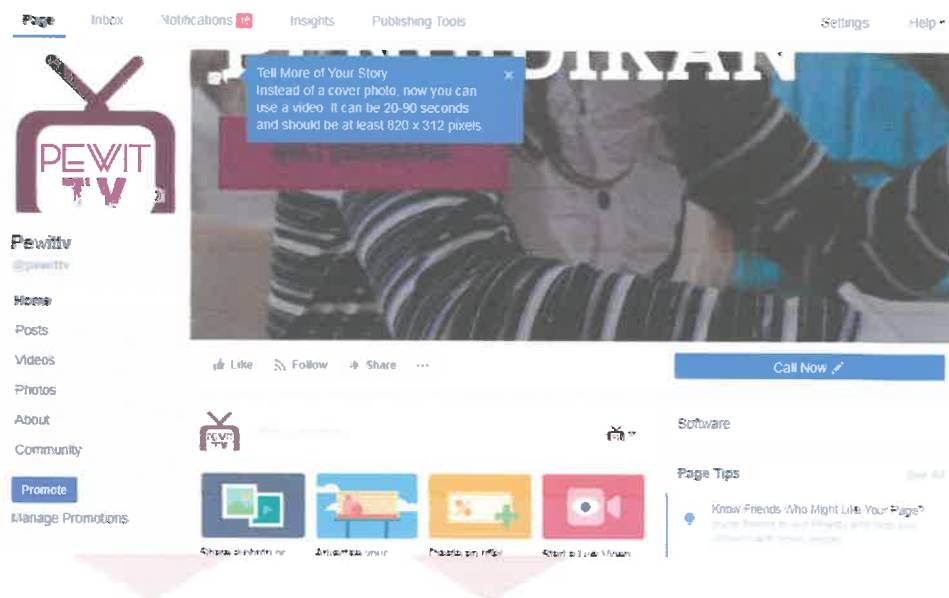

Figure 18 Pewittv Facebook Page

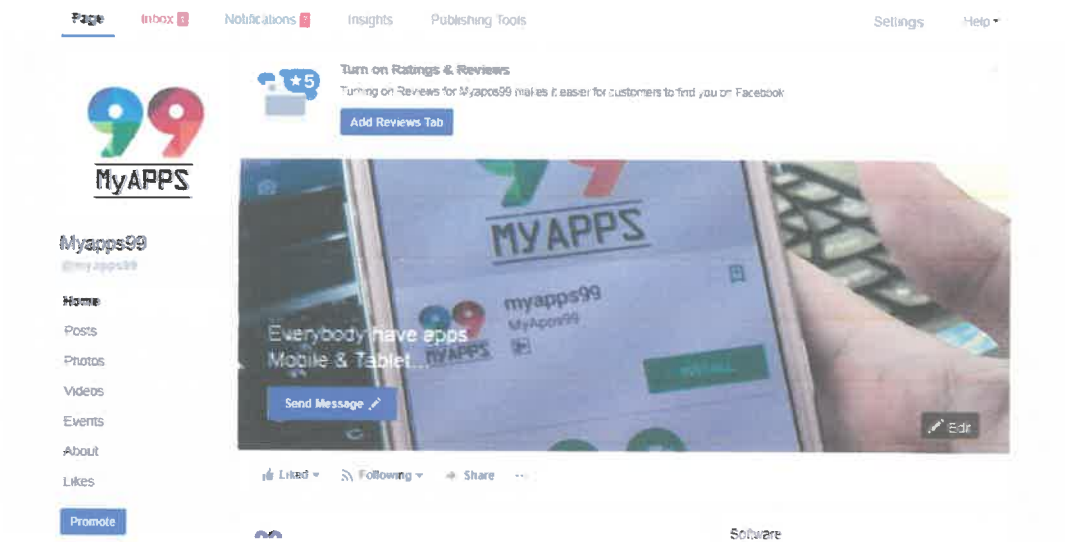

Figure 19 Myapps99 Facebook Page

3.1.4 Events

During the internship program, the trainee has been involved in several events. One of the events that the trainee has involved with is seminar. This seminar has been given a name as "Demi Seekor Kucing". This seminar is about to gain money by using passion. In this seminar, the trainee has been required to create and design the poster of the seminar. Other than that, the trainee is being assigned by the employer to give a speak on the program that being run by Era Bio Advance (M) Sdn. Bhd. which is known as Petspreneur Program.



Figure 20 Demi Seekor Kucing Event Poster

The other event that the trainee has joined is the SME week at the SACC Mall. The trainee has been sent to join this event and to manage the Myapps99 booth in this event for 4 days.

3.1.5 Video

During the internship program, the trainee has been involved with the video making. There are several videos that the trainee has made. One of the videos that have been made by the trainee is the video of Fur Grow Up. Other than that, the trainee also involve in the making of heboostyle video.



Figure 21 Era Bio Advance Raya Video

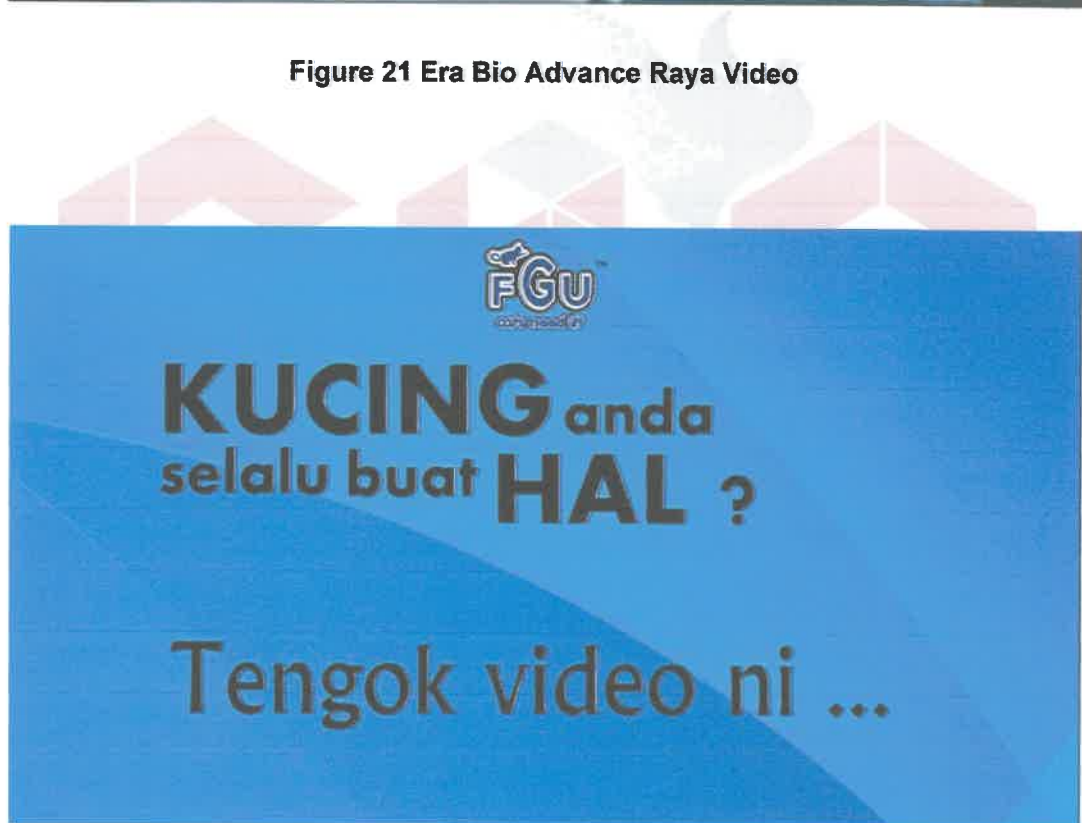

Figure 22 Poo Pee Spray Advertisement Video

3.1.6 Designing Flyers and posters

The trainee has been taking part in the designing of flyers and posters. There are several flyers and posters that has been design by the trainee.



Figure 23 Fur Grow Up Contest Flyers



Figure 24 Myapps99 Flyers

3.1.7 Meeting and presentation

During the internship program, the trainee has taking part in several meeting outside of the office and inside the office. One of the meetings outside of the office is a meeting with the SME Corp. Other than that, the trainee has a meeting with MDEC to propose the project of Era Bio Advance to MDEC. Furthermore, the trainee has involved in meeting with the Dewan Perdagangan Islam Malaysia Kuala Lumpur (DPIMKL).



Figure 25 Meeting at DPIMKL



Figure 26 Meeting at MDEC

3.2 Special Project

The Special Project that I have been given during my internship program at Era Bio Advance (M) Sdn. Bhd. is to develop a website and mobile application. The project that I get is being named as mysudip. This mysudip is a classified website for food and beverages. The main reason of this website is to help food and beverages company to promote their food and drinks. Basically this website and mobile application other function is to help people to search for any restaurant, catering or popular food around them so that they can find it easily. So the website for this project is being set as www.mysudip.com. Meanwhile, the mobile application for this project is call Dmysudip.



Figure 27 Mysudip Logo

3.2.1 Website Development

In the development of this project, the trainee is using one of the types of Content Management System (CMS) which is wordpress. Basically, Era Bio Advance (M) Sdn Bhd which is the company that the trainee going through the internship

program are using wordpress for all of the website under this company. So, based on the task that has been given by the employer, the trainee has been asked to use wordpress to develop this project. The duration of the development of this project is around 3 weeks. During the development process, the trainee is required to design the website from scratch. The logo of the brand also has been designed by the trainee.



Figure 28 mysudip.com/mysudip home page

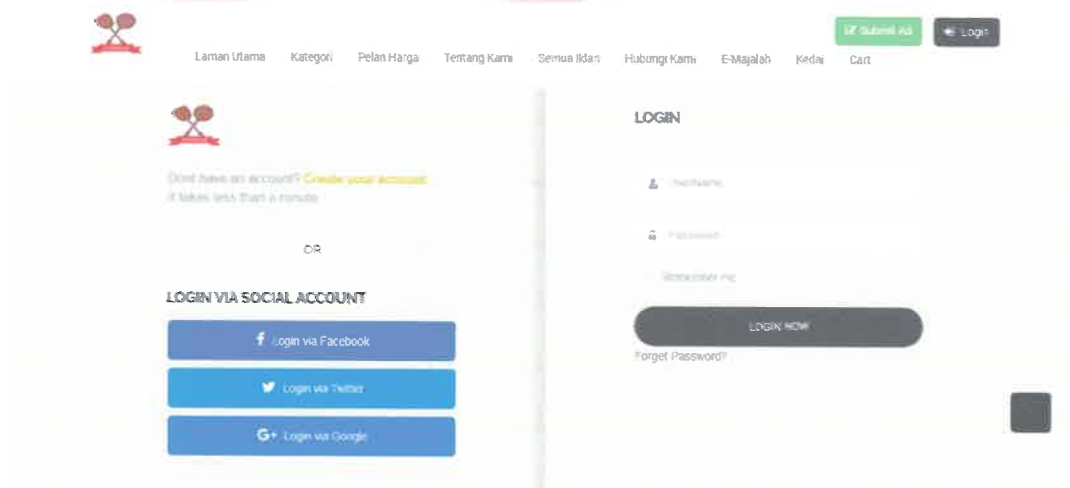

Figure 29 mysudip.com/mysudip Login Page

3.2.2 Mobile Application Development

The development of the mobile application, the trainee is required to develop the mobile application for Dmysudip. Basically, to develop this mobile application the trainee is required to use Myapps99 to develop the Dmysudip mobile application. The duration to develop the Dmysudip mobile application is 3 days including publish it to Google Playstore. During the process of the development of this mobile application, the trainee is required to design the interfaces of the mobile application. After the development has finished, the trainee is required to publish Dmysudip mobile application on Google Playstore.

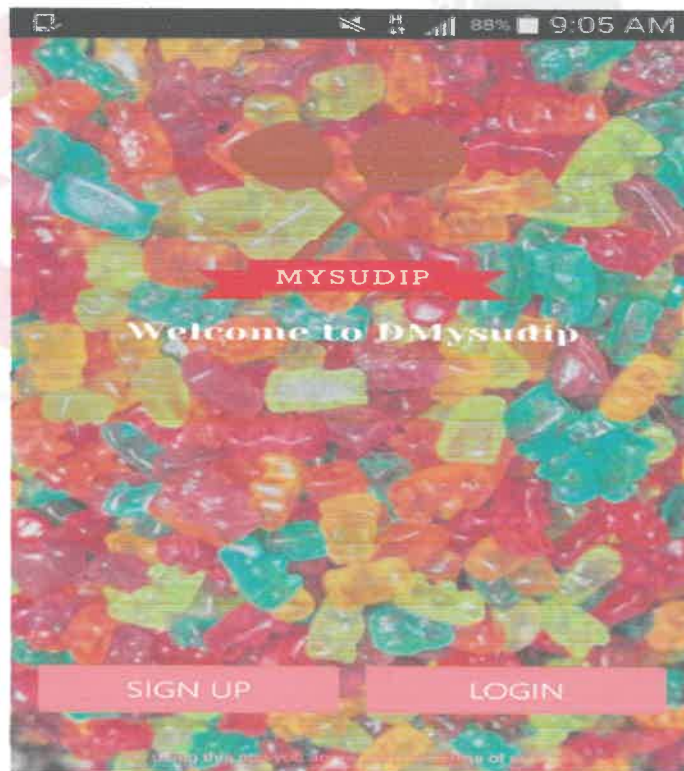

Figure 30 Dmysudip application Front page



Figure 31 Dmysudip application article page

3.2.1 Problem Statement

Era Bio Advance (M) Sdn. Bhd. is trying creates some project that will help all the people to find great places to have breakfast, lunch or dinner. So Era Bio Advance (M) Sdn. Bhd. has come out with an idea to make a website and mobile application where it can solve the problem.

3.2.2 Objective

The objective of the mysudip website and Dmysudip mobile application is to help their user to find a place to go for eat either for breakfast, lunch or dinner. Basically this website and mobile application is based on food and beverages. This website and mobile application consist of some function which is:

- This website and mobile application is connected to Google maps.
- User can login and logout.
- User with foods and beverages company or business can promote their own businesses.
- User can search restaurant near them.

3.2.3 Entity Relational Diagram

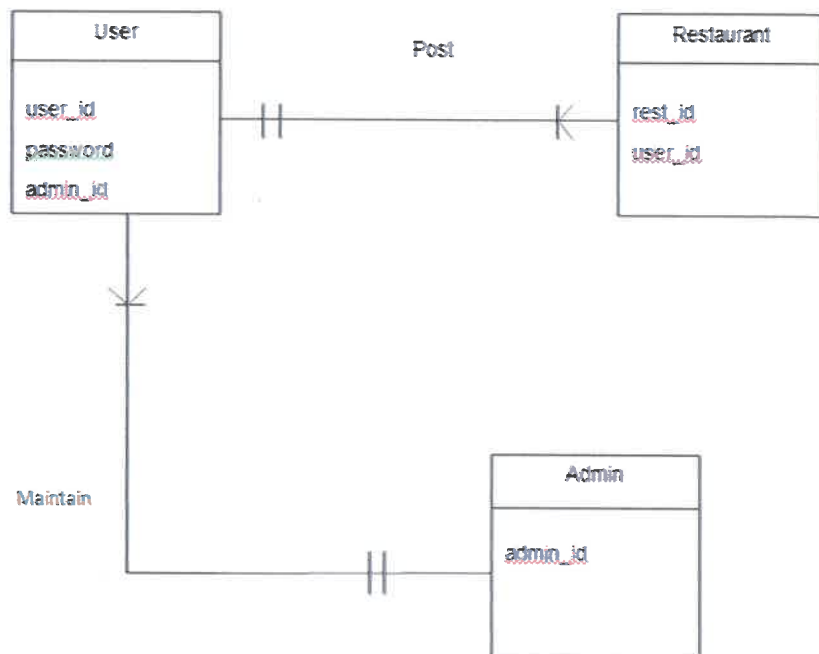
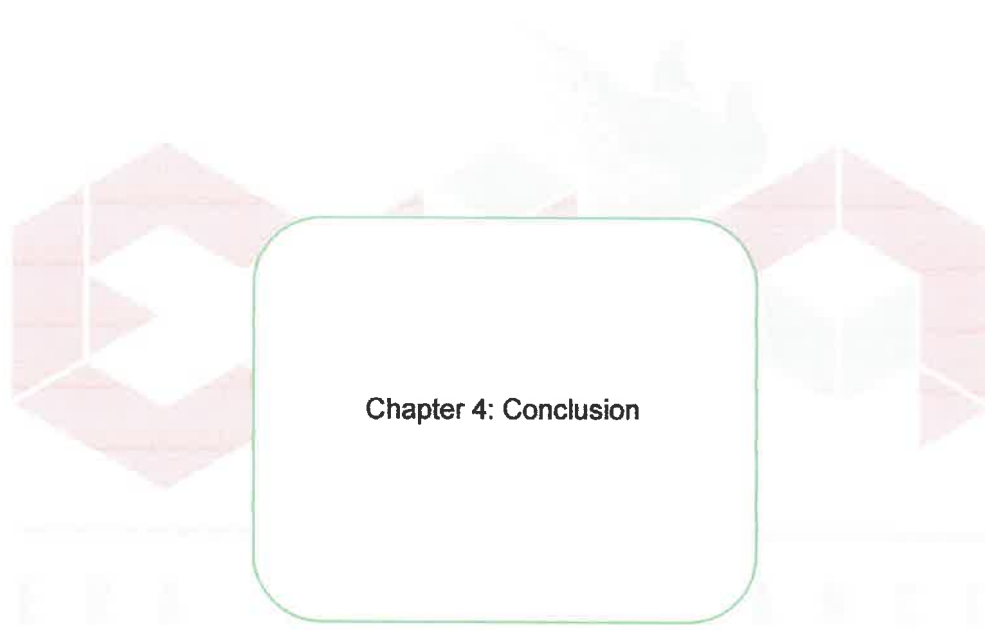

Figure 32 Mysudip Entity Relational Diagram



Chapter 4: Conclusion

4.1 Application of Knowledge, Skills and Experience

Project/ Activities	Knowledge	Skills	Experience	Related courses
Develop website	Knowledge from supervisor and the staff for web designing	Trainee will be able to finish the task with minimum guidance	Trainee learn how to develop a website	System Analysis in Information Management I & II (IMS606 & IMS655)
Special Project	Wordpress is one of the Content Management System (CMS).	The trainee able to enhance his skills in developing special project by using Wordpress and web development process based on what have been learned in System Analysis in Information Management I & II (IMS606 & IMS655).	The trainee able to learn on Wordpress.	System Analysis in Information Management I & II (IMS606 & IMS655)
Industrial training report	Knowledge in the writing of industrial training report based on guidelines given by the industrial training coordinator and thus, referred to IMS606, IMS655 and IMC651 subjects in order to develop the industrial training report until it is completed and fulfilled its criteria.	The trainee used several application software to draw the diagrams related in the developing the special project such as power point and paint. The trainee also gain more understanding in the three particular subjects so that the industrial training report are wrote correctly according to its requirements and information needed to be filled in it.	The trainee experienced in developing this industrial training documentation by himself starting from the first page of this report until the last pages. The trainee also able to applied his knowledge in developing both special project and industrial training report starting from the planning phase until maintenance phase.	Information SystemManagement (IMS552) System Analysis in Information Management I & II (IMS606 & IMS655) Evaluation of Information Services (IMC651).

4.2 Personal Thoughts and Opinion

In opinion, industrial training course is good subject for the student to learn new knowledge, skills and experience that cannot be learn in the class room and universities life. In five month during the internship, student can learn something different from the organization and gained new experience. The student will go through the process of learning during the internship period.

Industrial training course is beneficial for the student to gained working's experience. During the internship student can see and observe workers do their job tasks and learn how they perform their job. Trainee being able to gained new experience in handling task in faster ways. They always want trainee to complete the task in a short time because sometime that are to fulfil customer needed. As the programmer, in the company the staffs are always busy doing their job and give one hundred percent to the job to make sure that the task is complete perfectly and meet customer needed.

Moreover, trainee also learned that environment of working place in the Era Bio Advance (M) Sdn Bhd is different compare to university environment. In the university we are more learned the knowledge rather than applying the knowledge. While trainee was doing internship in industry, trainee need to applied all the knowledge and skills to do the job. The applying is the experience that trainee gained from the task on the company. Study from the experience make student more understand the task and the skills faster rather than study from the theory.

The trainee feels that the organization is giving a lot of experience and knowledge. The employer is giving a lot of opportunities for the trainee in order to improve the knowledge and experience of the trainee. All the staff in this company is very friendly and helpful. This kind of attitude created a very calm and interesting environment.

4.3 Lesson Learnt

Undergoing five months of industrial training phase gave trainee a lot of opportunity to learn on how to prepare myself to be information professional who qualified in serving the society in knowledge field. Through the industrial training, trainee has found few things as lesson for the future enhancement.

4.3.1. Time Management

As a student, trainee could have said that trainee always failed in managing time but that one aspect changed the moment trainee started industrial training at Era Bio Advance (M) Sdn Bhd. Trainee learns how to become a part of working society and how to manage time effectively. Trainee learned to set a priority according to the most important and least important things. In the organization, time is money and trainee learned that a good employee value their time. Trainee learned that people can actually be a time effective society if there is they are willing to do so.

4.3.3. Be responsible

Integrity is not something that can be installed to someone's behaviour, but they have to train themselves to abide to it. A good worker, trainee must show up for work when expected and work until it is time to quit. Begin and end coffee breaks and lunches as scheduled. Trainee also learnt to avoid spending time texting friends or making personal calls when there is work to be completed. Industrial training is an opportunity to see whether the work is satisfying to trainee and a career trainee want to pursue. By working as if trainee is already employed, trainee will get full benefit from the experience and the information to make a good career employment choice.

4.3.4. Improve self-confident

Furthermore, the next lesson learnt during the industrial training, it helps trainee to improve trainee self-confident level. Self-confidence is extremely important in almost every aspect of our lives, yet so many people struggle to find it. Becoming more confident is readily achievable, just as long as you have the focus and determination. During practical training, trainee was able to improve the level of trainee self-confidence by mingling with the users and also the staff. Trainee learned that there is no short cut to improve self unless trainee is willing to do so. Therefore, trainee used the opportunity as an industrial student to do whatever it takes to gain trainee self-confidence. Most of the time, trainee had the opportunity to speak up to the all staff even to the top management and also through duty as person of contact of Mysudip project.

4.3.5. Leadership

Trainee also learned that leadership is important because a good leader can be good example for their staff. A leader is someone who leads the people of the organization. The leader works to consistently influence the employees to do better. A good leader should know how to motivate their staff and good leader also should accept opinion from staff especially opinion that can make improvement in company.

4.4 Limitations and Recommendations

4.4.1 Limitations

There are several limitations that I face during my industrial training. Firstly, the department that trainee is assigned to join which is programmer department have a lack of manpower. This problem is causes trainee having too much of workload and sometimes trainee must stay back at the company to finish the work until late night.

Secondly, trainee have a problem to having a reference regarding the project that be assigned to trainee. This is because they don't have a proper project documentation to refer and it cause trainee take much time to understand the real thing about the project at the first place. Lastly is the issue is that the company does not have any experience staff or staff that expert in this department since all of the workers at this department was an intern students.

4.4.2 Recommendations

One of the recommendations is that Era Bio Advance (M) Sdn Bhd should hire more manpower due to reduce the workload of the existing staff and workers. Other than that, this company should hire and experience and expert staff in each department so that each department will have a mastermind other than just hiring internship students.

5.0 References

(n.d.). Retrieved July 8, 2017, from <https://myapps99.com/about/>

(n.d.). Retrieved July 8, 2017, from <http://mysudip.com/mysudip/>

About us. (n.d.). Retrieved July 8, 2017, from <https://kucingsayang.com/pages/about-us>

Appendices



INNOVATION ADVANCE